



**GENERATOR TYPE ECO 40-1.5L/4**

Document : **DS069A/1**

issue 006 date 21/03/2014

<b>Electrical Characteristics</b>										
Frequency	Hz	50				60				
Voltage (parallel star)	V	380	400	415	440	415	440	460	480	
Rated power class H	kVA	620	620	620	570	660	700	744	744	
	kW	496	496	496	456	528	560	595	595	
Rated power class F	kVA	560	560	560	515	600	632	672	672	
	kW	448	448	448	412	480	506	538	538	
Regulation with	DER1	±1% with any power factor and speed variations between -5% +30%								
Insulation class		H								
Execution		Brushless								
Stator winding		12 ends								
Rotor		with damping cage								
Efficiencies class H	4/4	%	94,7	94,9	94,6	94,4	95,4	95,8	95,9	96,1
(see graph. for details)	3/4	%	94,9	95,1	94,9	94,6	95,6	96	96,1	96,3
	2/4	%	94,1	94,2	94,1	94	94,8	94,9	95	95,2
	1/4	%	90,5	90,6	90,6	90,4	91,6	91,6	91,7	91,8
<b>Reactances (f. l.cl. F)</b>										
	Xd	%	285	250	135	85	430	370	285	250
	Xd'	%	19,6	18,4	17,6	16,4	20,9	19,6	19,6	18,4
	Xd''	%	10,8	9,8	9,1	8,7	11,4	10,7	10,8	9,8
	Xq	%	156	146	128	114	162	158	156	146
	Xq'	%	156	146	128	114	162	158	156	146
	Xq''	%	23,7	22,3	21,2	20,7	24,3	23,4	23,7	22,3
	X <sub>2</sub>	%	12,4	11,5	10,7	9,3	13,4	12,6	12,4	11,5
	X <sub>0</sub>	%	3,1	2,7	2,5	2,2	3,5	3,2	3,1	2,7
Short Circuit Ratio	Kcc		0,35	0,40	0,75	1,30	0,23	0,27	0,35	0,40
Time Constants	Td'	sec.	0,15							
	Td''	sec.	0,019							
	Tdo'	sec.	3,10							
	Tα	sec.	0,04							
Short Circuit Current Capacity		%	>300				>350			
Excitation at no load	Amp.		0,65	0,74	0,8	0,95	0,47	0,54	0,6	0,65
Excitation at full load	Amp.		3	3,1	3,5	3,6	2,3	2,5	2,8	3
Overload (long-term)	%	1 hour in a 6 hours period 110% rated load								
Overload per 20 sec.	%	300								
Stator Winding Resistance (20°C)	Ω	0,0087								
Rotor Winding Resistance (20°C)	Ω	1,376								
Exciter Resistance (20 °C)	Ω	Rotor : 0,050				Stator : 8,85				
Heat dissipation at f.l.cl.H	W	27759	26655	28313	27051	25459	24551	25447	24155	
Telephone Interference		THF < 2%				TIF < 40				
Radio interference		EN61000-6-3, EN61000-6-2. For others standards apply to factory								
Waveform Distors.(THD) at f. load	LL/LN %	2,2 / 2,4								
Waveform Distors.(THD) at no load	LL/LN %	2,4 / 2,5								
<b>Mechanical characteristics</b>										
Protection		IP 21 (other protection on request )								
DE bearing		6322								
NDE bearing		6318.2RS								
Weight of wound stator assembly	kg	524								
Weight of wound rotor assembly	kg	369								
Weight of complete generator	kg	1380								
Maximun overspeed	rpm	2250								
Unbalanced magnetic pull at f.l.cl.F	kN/mm	6,1								
Cooling air requirement	m <sup>3</sup> /min	54				64,8				
Inertia Constant (H)	sec.	0,179				0,214				
Noise level at 1m/7m	dB(A)	94 / 82				98 / 88				

All technical data are to be considered as a reference and they can be modified without any notice.

This document is a propriety of Mecc Alte S.p.A.. All rights reserved.



GENERATOR TYPE ECO 40-1.5L/4

Document : DS069A/2  
 issue 003 date : 21/03/2014

**50 Hz**

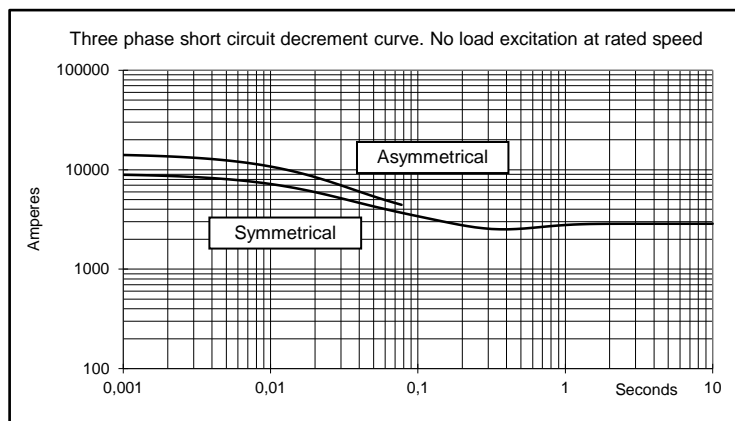
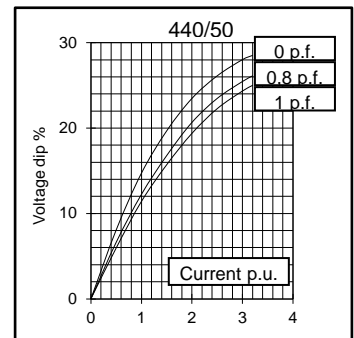
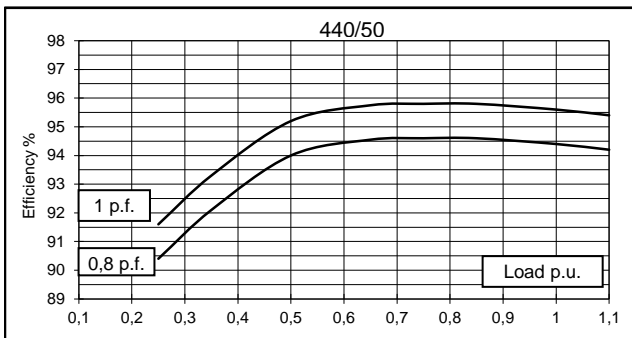
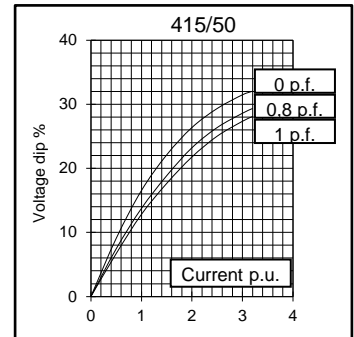
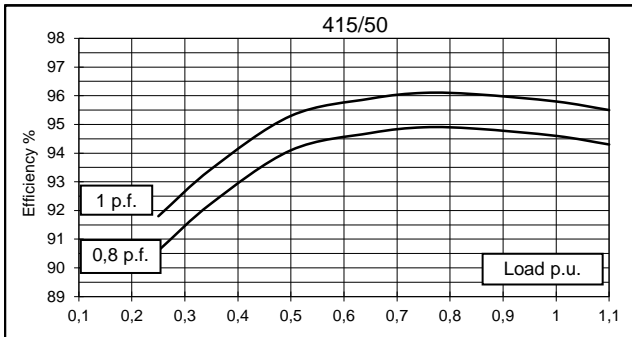
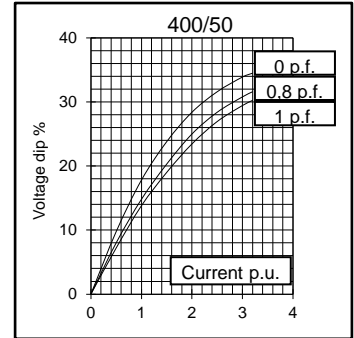
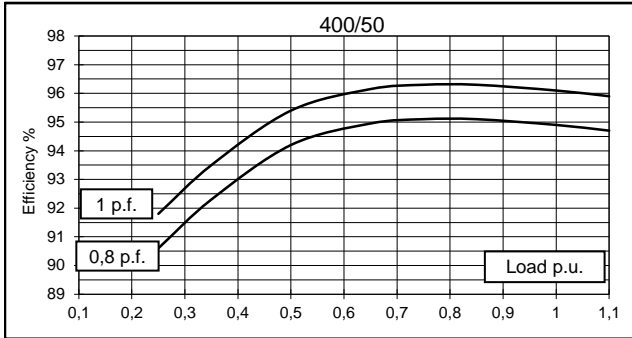
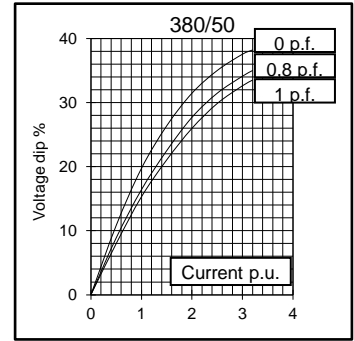
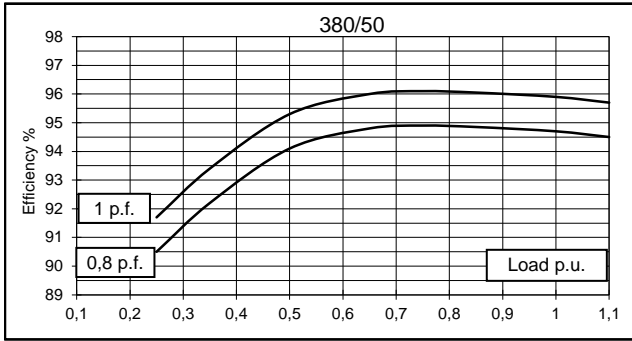

**60 Hz**

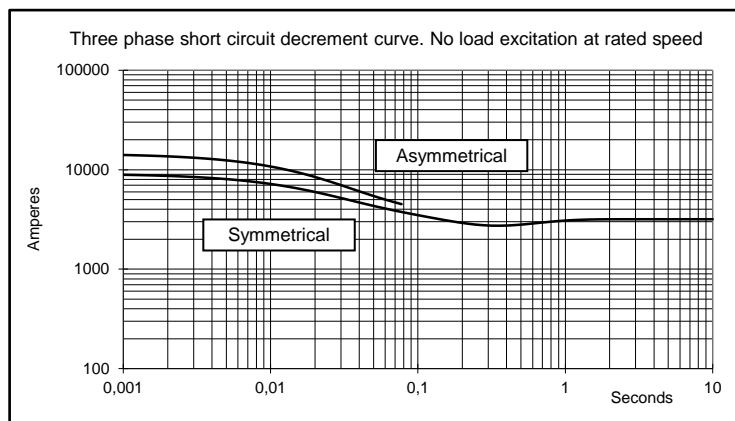
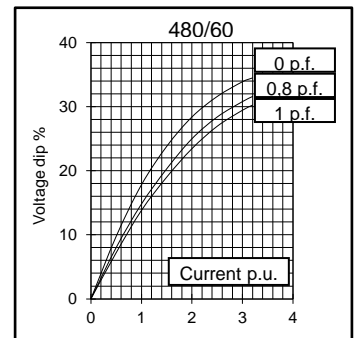
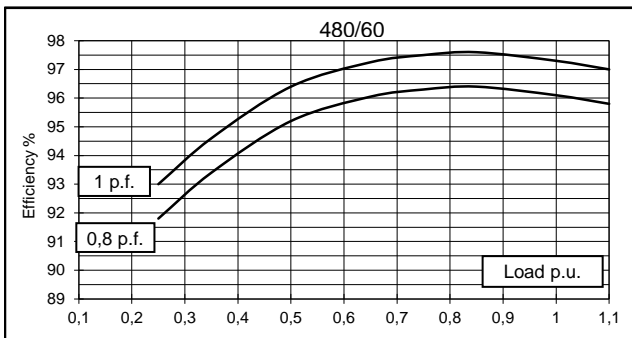
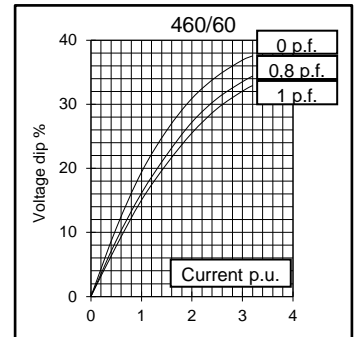
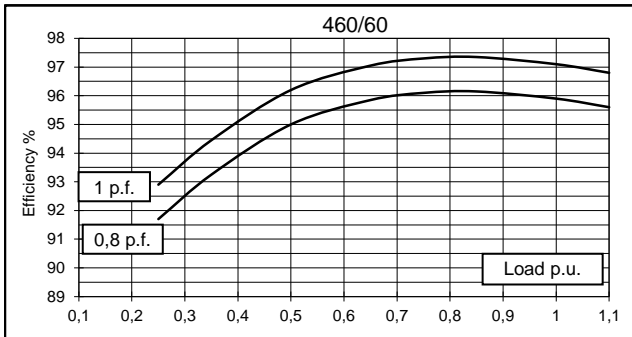
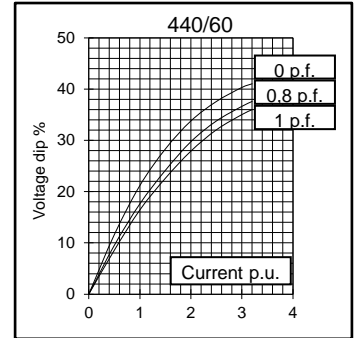
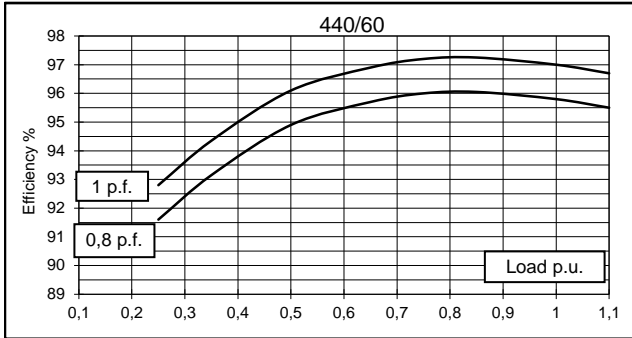
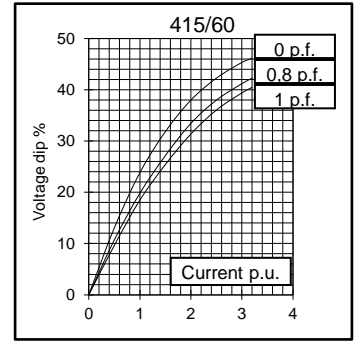
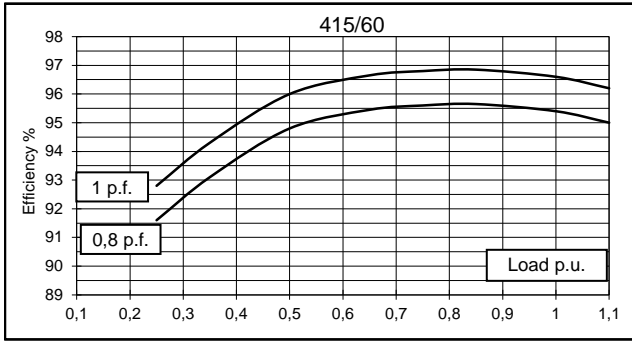

TWO BEARING MOMENTS OF INERTIA

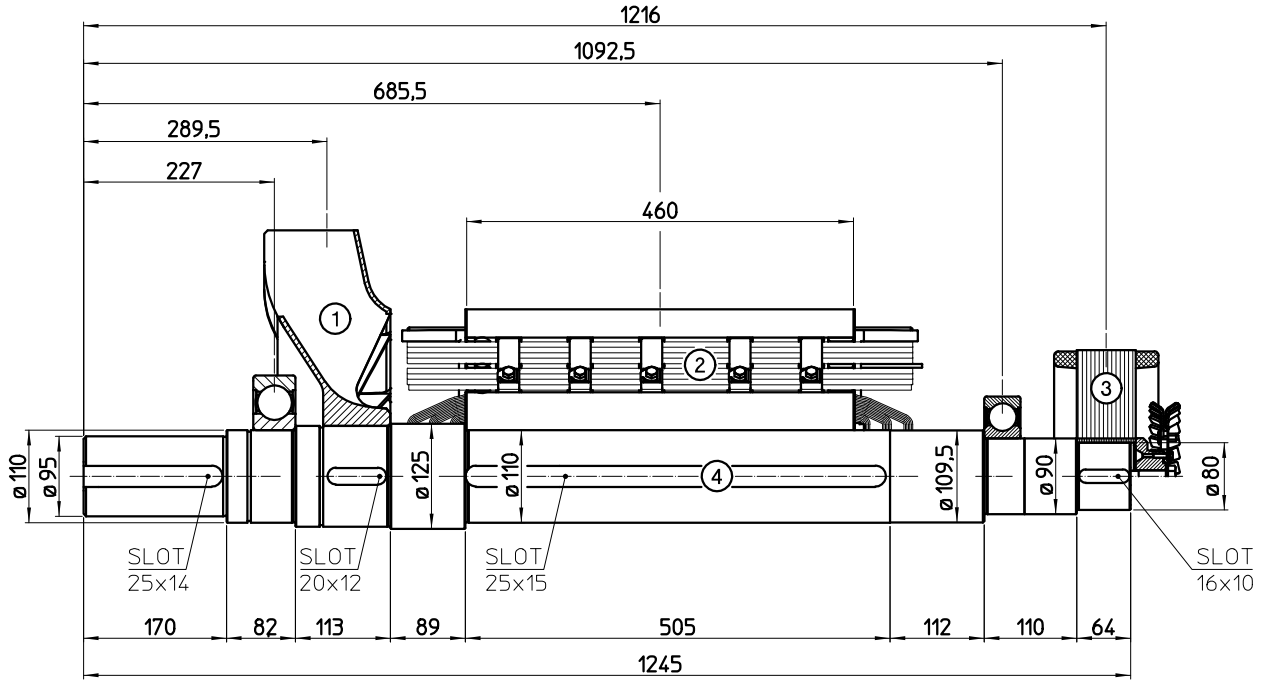

COMPONENT	WEIGHT kg	J kgm <sup>2</sup>
1 FAN	10,2	0,335
2 MAIN ROTOR	369	7,715
3 EX. ROTOR	35	0,562
4 SHAFT	85,7	0,127
TOTAL	499,9	8,739

TWO BEARING DIMENSIONS

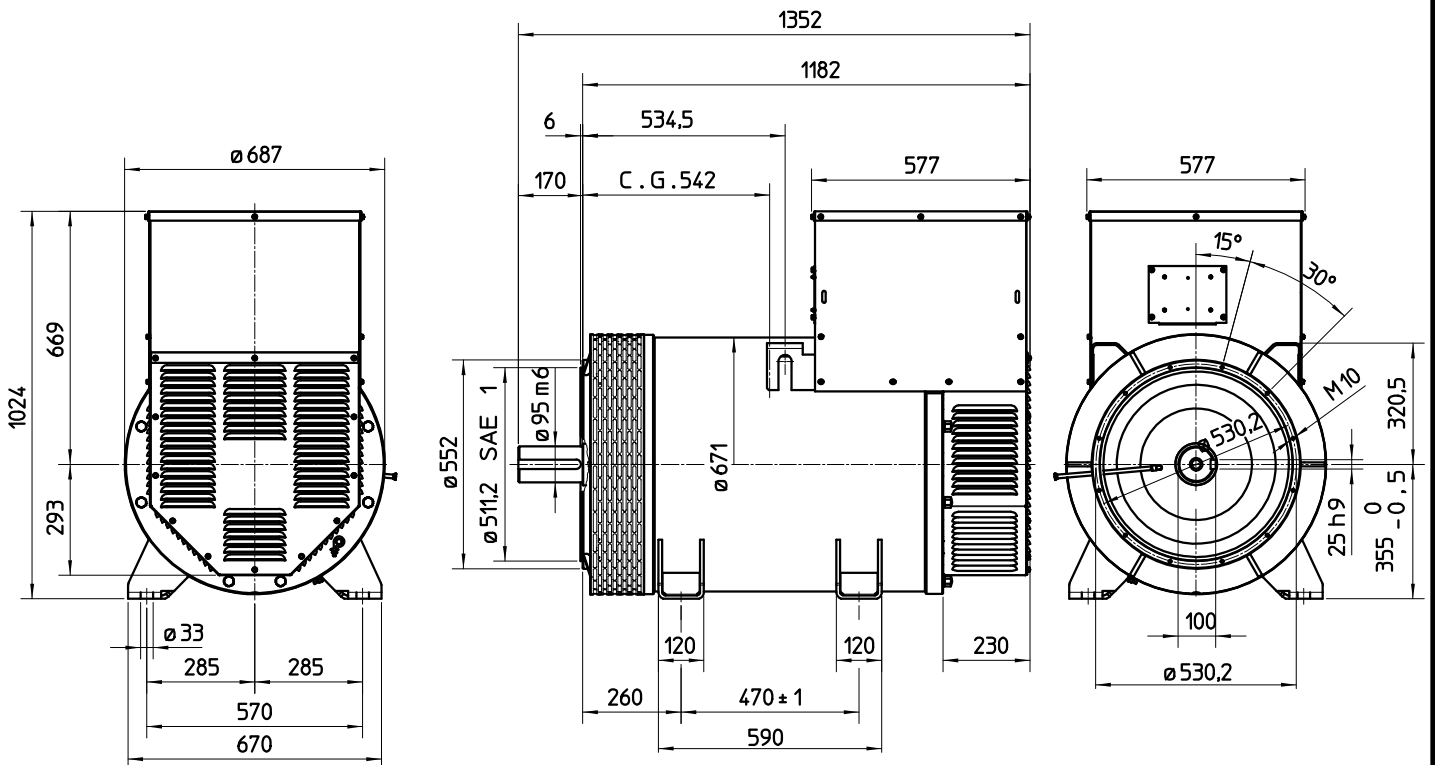

C.G.= GRAVITY CENTER

### SINGLE BEARING MOMENTS OF INERTIA

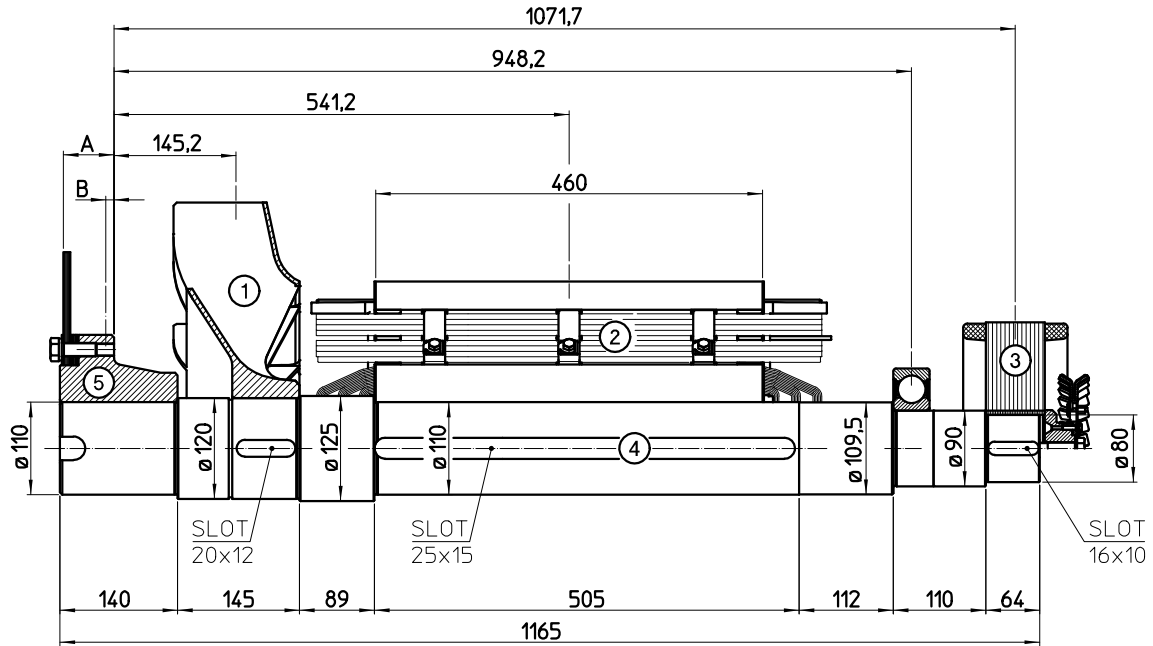

COMPONENT	WEIGHT kg	J kgm <sup>2</sup>
1 FAN	10,2	0,335
2 MAIN ROTOR	369	7,715
3 EX. ROTOR	35	0,562
4 SHAFT	84,2	0,129
TOTAL	498,4	8,741

Sae No	SHAFTS COUPLING FLEX PLATE			
	A	B	WEIGHT kg	J kgm <sup>2</sup>
14	60	9,6	41,4	0,511
18	50	6,6	45,1	0,858

### SINGLE BEARING DIMENSIONS

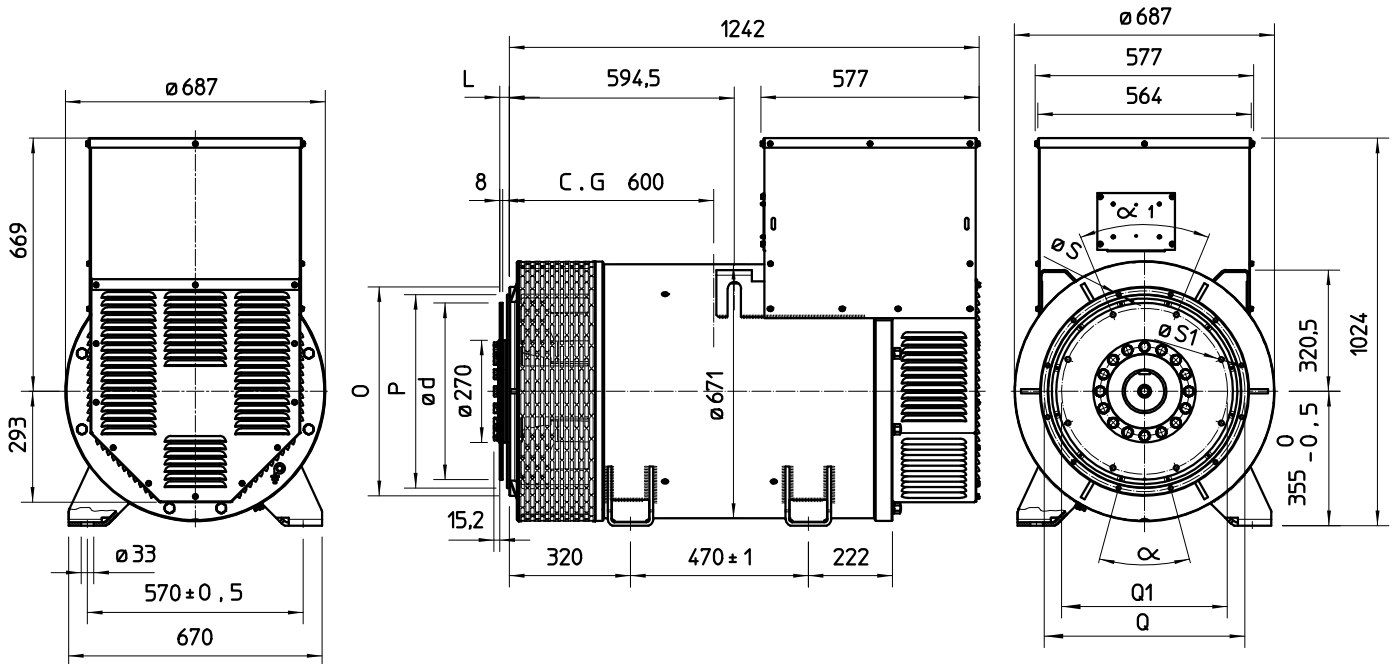

SAE N.	FLANGIA / FLANGE BRIDE / FLANSCH					
	O	P	Q	N. FORI	S	α
1	552	511,2	530,2	12	11	30°
1/2	648	584,2	619,1	12	14	30°
0	711	647,7	679,5	16	14	22,5°
00	883	787,4	850,9	16	14	22,5°

VOL. N.	GIUNTI A DISCHI / DISC COUPLING DISCQUE DE MONOPALIER / SCHEIBENKUPPLUNG					
	L	d	Q1	N. FORI	S1	α1
14	25,4	466,72	438,15	8	14	45°
18	15,7	571,5	542,92	6	17	60°

C.G.= GRAVITY CENTER