

Electrical Characteristics										
Frequency	Hz	50				60				
Voltage (star)	V	380	400	415	440	415	440	460	480	
Rated power class H	kVA	25	25	25	-	26	27,5	30	30	
	kW	20	20	20	-	20,8	22	24	24	
Rated power class F	kVA	23	23	23	-	24	25,5	27,5	27,5	
	kW	18	18	18	-	19,2	20,4	22	22	
Regulation with SR7/2		±1,5 % with any power factor and speed variations between -5% +30%								
Insulation class		H								
Execution		Brushless								
Stator winding		12 ends								
Rotor		without damping cage								
Efficiencies class H	4/4	%	87,6	88	88,3	-	89	89,3	89,5	89,9
(see graph. for details)	3/4	%	88	88,3	88,4	-	89,5	89,7	89,9	90,1
	2/4	%	86,1	86,2	86,2	-	87,9	88	88,1	88,2
	1/4	%	84	83,8	83,8	-	86,1	85,9	86,1	86
Reactances (f. l.cl. F)	Xd	%	201,7	182	169,1	-	211,0	198,5	198,2	182
	Xd'	%	17,73	16	14,86	-	18,55	17,45	17,42	16
	Xd"	%	9,97	9	8,36	-	10,43	9,82	9,80	9
	Xq	%	82,0	74	68,7	-	85,8	80,7	80,6	74
	Xq'	%	82,0	74	68,7	-	85,8	80,7	80,6	74
	Xq"	%	22,2	20	18,6	-	23,2	21,8	21,8	20
	X ₂	%	14,96	13,5	12,54	-	15,65	14,73	14,70	13,5
	X ₀	%	3,32	3	2,79	-	3,48	3,27	3,27	3
Short Circuit Ratio	Kcc		0,50	0,60	0,80	-	0,38	0,43	0,50	0,60
Time Constants	Td'	sec.	0,048							
	Td"	sec.	0,014							
	Tdo'	sec.	0,95							
	Tα	sec.	0,012							
Short Circuit Current Capacity		%	>300				>350			
Excitation at no load	Amp.		0,45	0,6	0,7	-	0,3	0,4	0,5	0,55
Excitation at full load	Amp.		1,4	1,6	1,8	-	1,3	1,4	1,5	1,6
Overload (long-term)		%	1 hour in a 6 hours period 110% rated load							
Overload per 20 sec.		%	300							
Stator Winding Resistance (20°C)		Ω	0,269							
Rotor Winding Resistance (20°C)		Ω	1,806							
Exciter Resistance (20 °C)		Ω	Rotor : 0,64				Stator : 10,60			
Heat dissipation at f.l.cl.H	W		2831	2727	2650	-	2571	2636	2816	2696
Telephone Interference			FHT < 2%				TIF < 45			
Radio interference			EN50081-1, EN50082-1, VDE 0875K. For others standards apply to factory							
Waveform Distors.(THD) at f. load	LL/LN %		2 / 2							
Waveform Distors.(THD) at no load	LL/LN %		3,4 / 3,2							
Mechanical characteristics										
Protection			IP 23 (other protection on request)							
DE bearing			6309-2RS							
NDE bearing			6209-2RS							
Weight of wound stator assembly	kg		53							
Weight of wound rotor assembly	kg		28,2							
Weight of complete generator	kg		144							
Maximun overspeed	rpm		2250							
Unbalanced magnetic pull at f.l.cl.F	kN/mm		4,5							
Cooling air requirement	m ³ /min		5,3				5,8			
Inertia Constant (H)	sec.		0,074				0,089			
Noise level at 1m/7m	dB(A)		68 / 57				71 / 61			

50 Hz

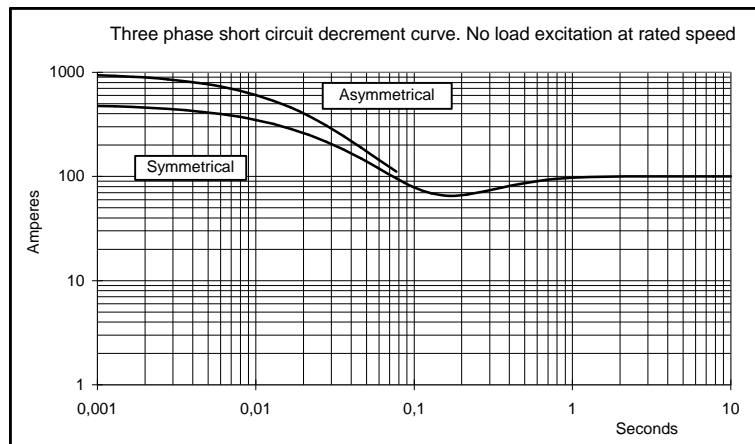

60 Hz

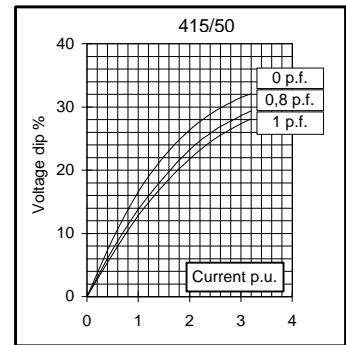
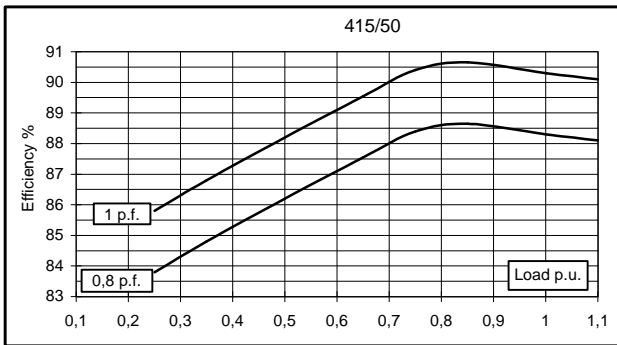
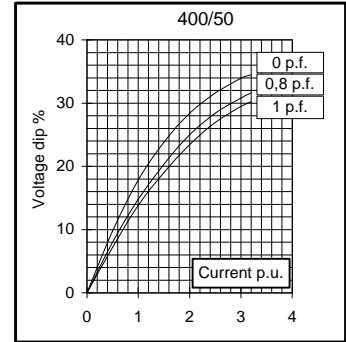
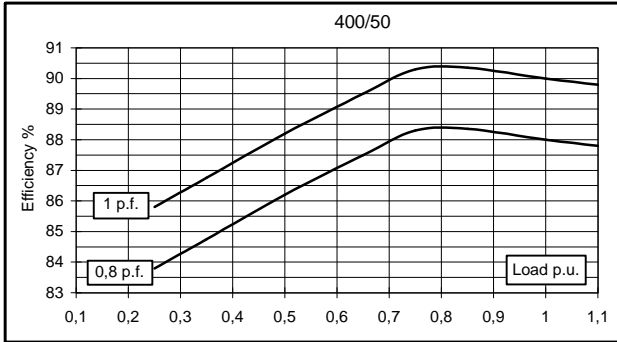
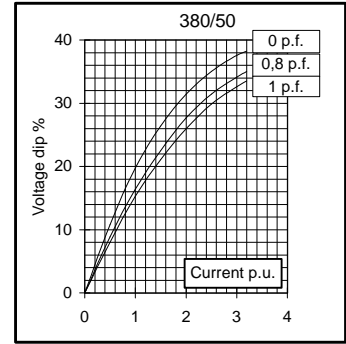
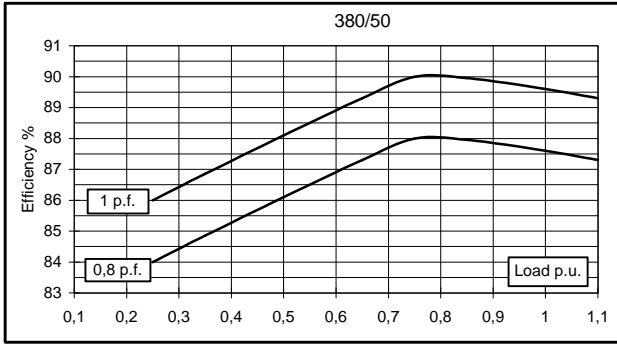
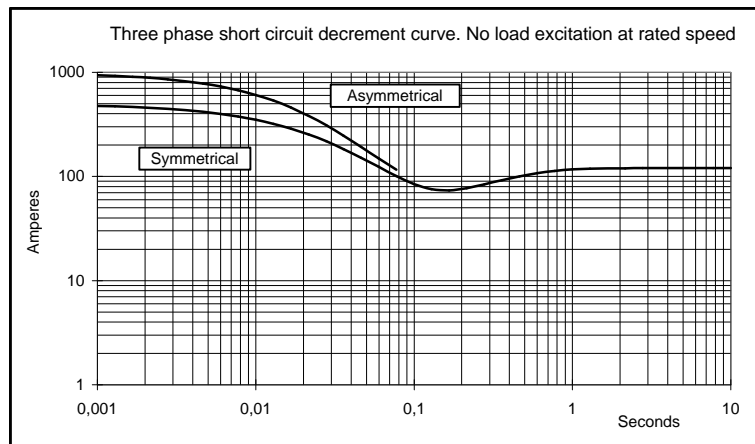
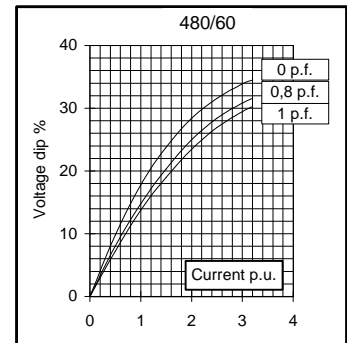
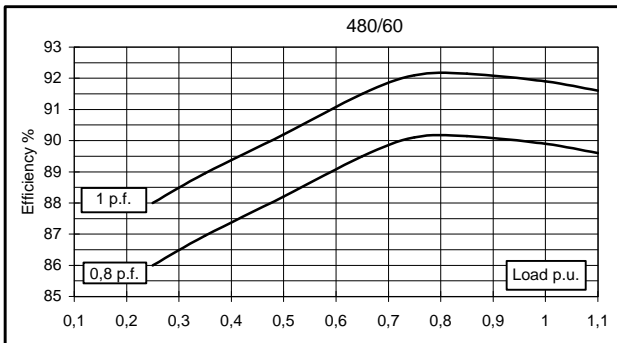
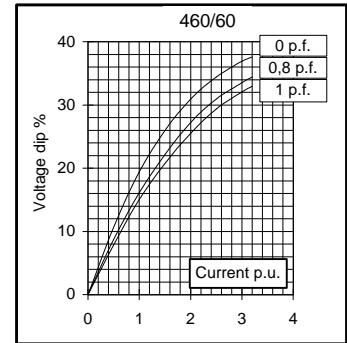
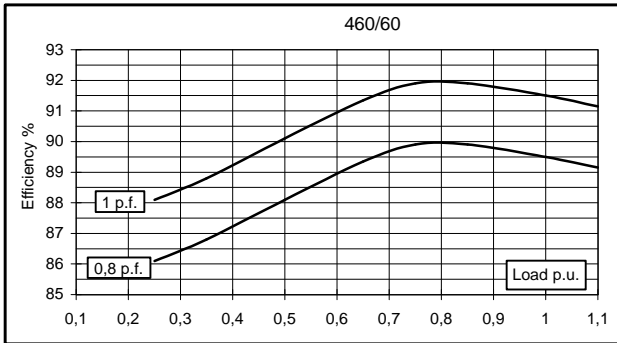
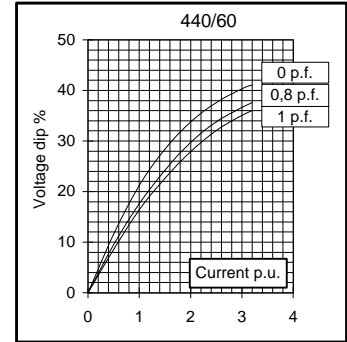
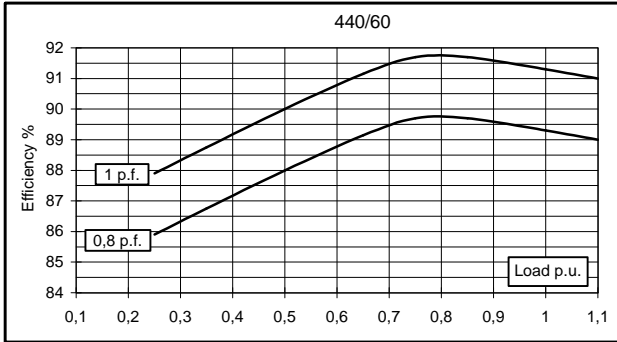
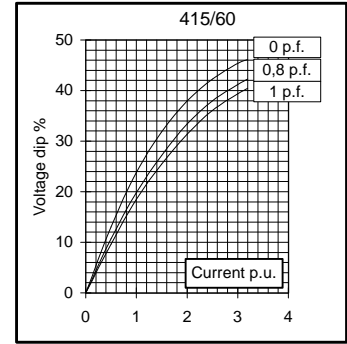
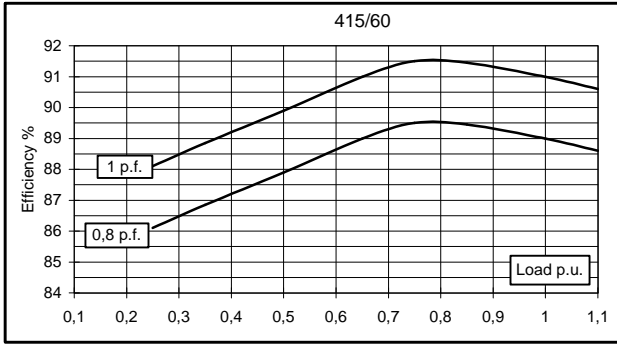

TWO BEARING MOMENTS OF INERTIA

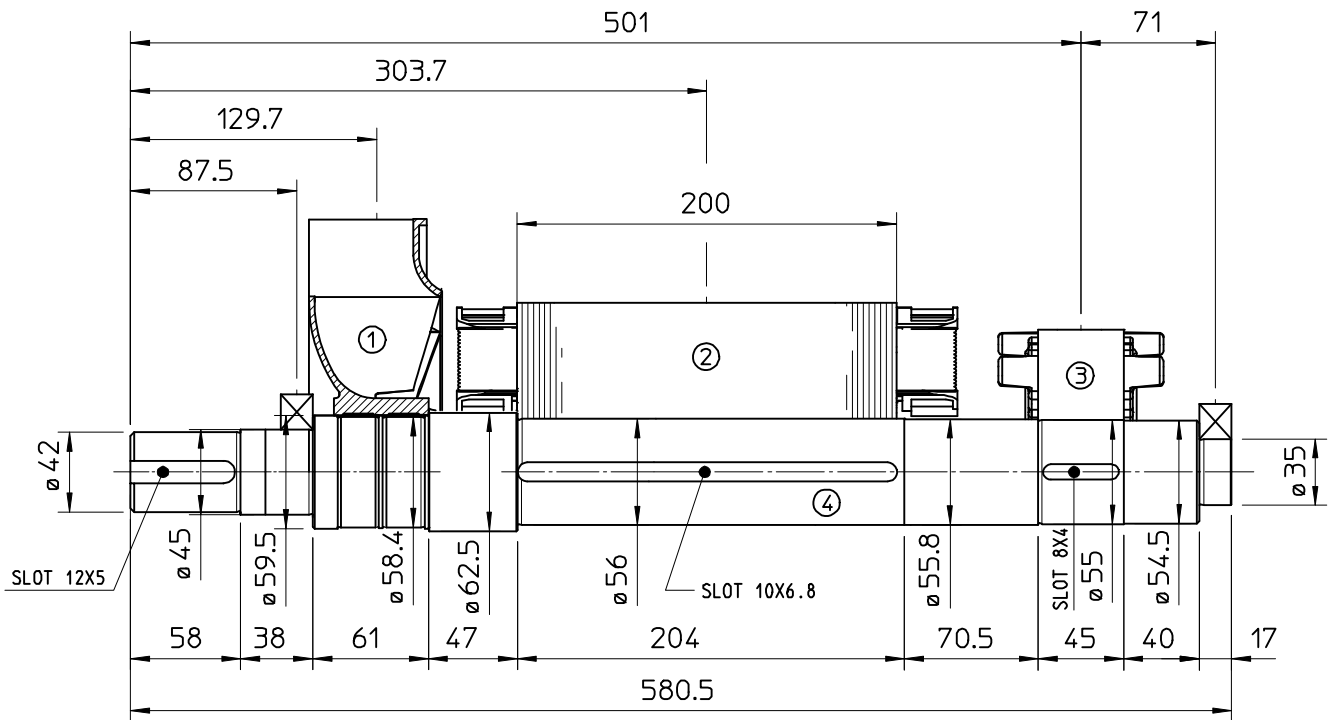

COMPONENT	WEIGHT Kg	J Kg ^m ²
1 FAN	1.2	0.0102
2 MAIN ROTOR	28.2	0.123
3 EX ROTOR	5.4	0.012
4 SHAFT	10.6	0.004
6 TOTAL	45.4	0.1492

TWO BEARING DIMENSIONS

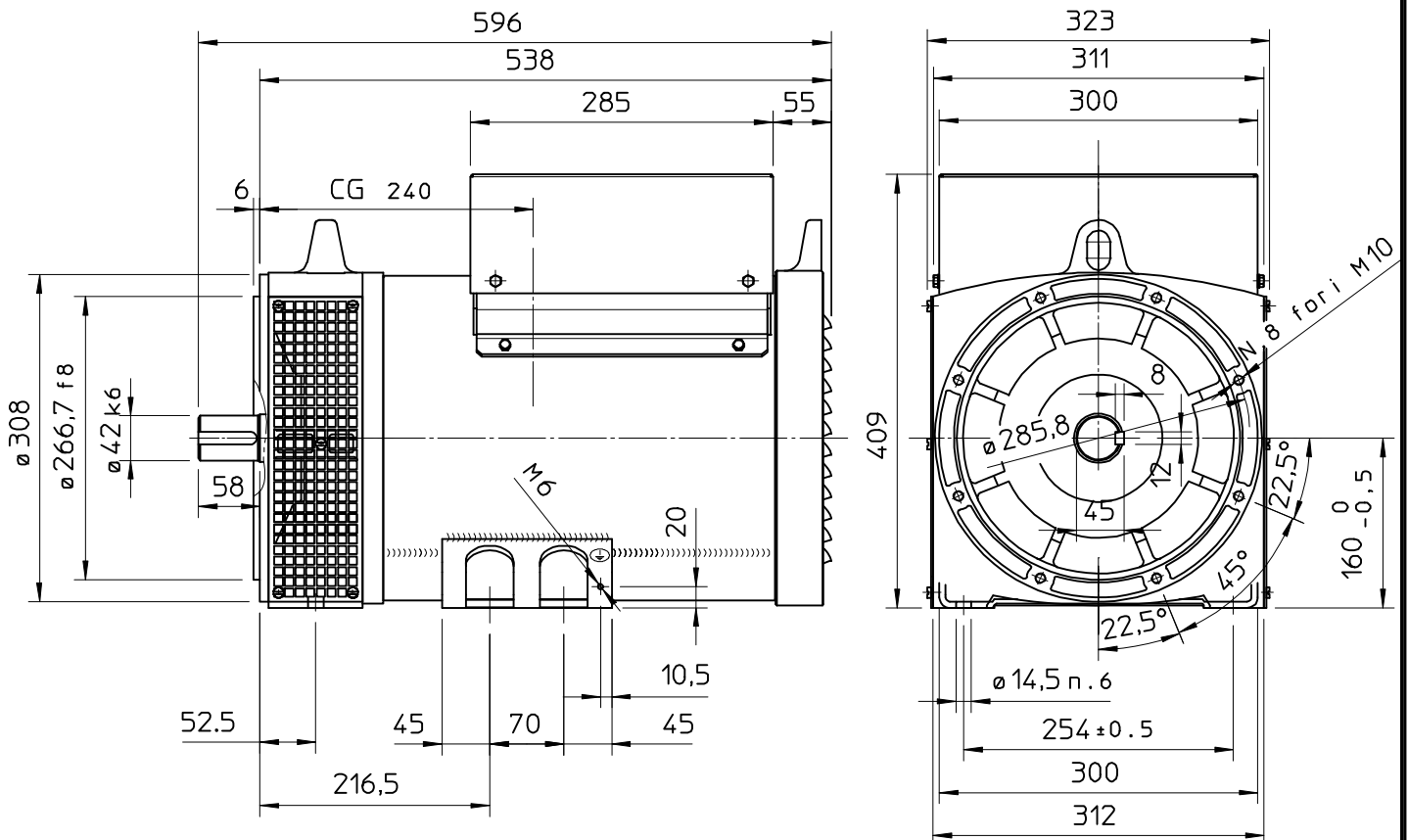

C.G. = GRAVITY CENTER

