

**LSA 47.3**

**Low Voltage Alternator - 4 pole**

410 to 660 kVA - 50 Hz / 510 to 825 kVA - 60 Hz  
Electrical and mechanical data

**LEROY-SOMER™**

***Nidec***  
All for dreams

## The best of performance

Nidec Leroy-Somer LSA 47.3 alternator has been designed to offer you the best power generation performances. With its meticulous design and optimized architecture, the LSA 47.3 strikes the perfect balance between compactness, reliability, performance and longevity.

Whatever your application, the LSA 47.3 will meet your needs and will adapt to all situations.

## Standards

Nidec Leroy-Somer LSA 47.3 alternator meets all key international standards and regulations, including IEC 60034, NEMA MG 1.32-33, ISO 8528-3, CSA C22.2 n°100-14 and UL 1446 (UL 1004 on request). Also compliant with IEC 61000-6-2, IEC 61000-6-3, IEC 61000-6-4, VDE 0875G, VDE 0875N and EN 55011, group 1 class A for European zone.

Nidec Leroy-Somer LSA 47.3 alternator can be integrated in EC marked generator set, and bears EC and CMIM markings.

It is designed, manufactured and marketed in an ISO 9001 and ISO 14001 quality assurance environment.

## Electrical characteristics and performances

- Class H insulation
- 2/3 pitch winding, standard 12-wire (6) reconnectable
- Voltage range:
  - 50 Hz: 220V - 240V and 380V - 415V (440V)
  - 60 Hz: 208V - 240V and 380V - 480V
- High efficiency and motor starting capacity
- Other voltages are possible with optional adapted windings:
  - 50 Hz: 440V (no. 7), 500V (no. 9), 550V (no. 22 or 23), 600V (no. 22 or 23), 690V (no. 10 or 52)
  - 60 Hz: 380V and 416V (no. 8), 600V (no. 9), 690V (no. 22 or 23)

## Excitation and regulation system

Excitation system				Regulation options		
AVR	SHUNT	AREP (option)	PMG (option)	C.T. Current transformer for paralleling	Mains paralleling	Remote voltage potentiometer
R250	Standard					√
D350	Option	Standard	Standard	√*		√
D550	Option	Option	Option	√*	√	√

\*: only with AREP or PMG

3-phase sensing is included as a standard with digital regulators.

## Protection system and options

- The LSA 47.3 is IP 23
- Complete winding protection for clean environments with relative humidity  $\leq 95\%$ , including indoor marine environments
- Options:
  - Filters on air inlet: derating 5%
  - Filters on air inlet and air outlet (IP 44): derating 10%
  - Reinforced winding protection for harsh environments and relative humidity greater than 95%
  - Space heater
  - Thermal protection for stator windings and shields

## Mechanical construction

- Compact and rigid assembly to better withstand generator vibrations
- Steel frame
- Cast iron flanges and shields
- Two-bearing and single-bearing versions designed to be suitable for engines on the market
- Half-key balancing
- Greased for life bearings, regreasable bearings (optional)
- Standard direction of rotation: clockwise when looking at the drive end view (for anti-clockwise, derate the machine by 5%)

## Terminal box design

- Easy access to the voltage regulator and to the connections
- Possible inclusion of accessories for paralleling, protection and measurement
- 9-way terminal block for voltage reconnection

# LSA 47.3 - 410 to 660 kVA - 50 Hz / 510 to 825 kVA - 60 Hz

## General characteristics

Insulation class	H	Excitation system	SHUNT	AREP / PMG
Winding pitch	2/3 (wind. 6)	AVR type	R250	D350
Number of wires	12	Voltage regulation (*)	± 0.5%	± 0.25%
Protection	IP 23	Short-circuit current	-	300% (3 IN) : 10s
Altitude	≤ 1000 m	Total Harmonic Distortion THD (**)	no load < 1.5% - on load < 2%	
Overspeed	2250 R.P.M.	Waveform: NEMA = TIF (**)	< 50	
Air flow	0.9 m³/s (50 Hz) / 1.1 m³/s (60 Hz)	Waveform: I.E.C. = THF (**)	< 2%	

(\*) Steady state (\*\*) Total harmonic distortion between phases, no-load or on-load (non-distorting)

## Ratings 50 Hz - 1500 R.P.M.

kVA / kW - P.F. = 0.8																	
Duty / T° C		Continuous / 40 °C				Continuous / 40 °C				Stand-by / 40 °C				Stand-by / 27 °C			
Class / T° K		H / 125° K				F / 105° K				H / 150° K				H / 163° K			
Phase		3 ph.				3 ph.				3 ph.				3 ph.			
<b>Y</b>		380V	<b>400V</b>	415V	440V	380V	<b>400V</b>	415V	440V	380V	<b>400V</b>	415V	440V	380V	<b>400V</b>	415V	440V
<b>Δ</b>		220V	<b>230V</b>	240V		220V	<b>230V</b>	240V		220V	<b>230V</b>	240V		220V	<b>230V</b>	240V	
<b>YY</b>			<b>200V</b>		220V		<b>200V</b>		220V		<b>200V</b>		220V		<b>200V</b>		220V
<b>LSA 47.3 S4</b>	kVA	410	<b>410</b>	410	400	375	<b>375</b>	375	364	435	<b>435</b>	435	424	450	<b>450</b>	450	440
	kW	328	<b>328</b>	328	320	300	<b>300</b>	300	291	348	<b>348</b>	348	339	360	<b>360</b>	360	352
<b>LSA 47.3 S5</b>	kVA	455	<b>455</b>	455	445	415	<b>415</b>	415	405	480	<b>480</b>	480	472	500	<b>500</b>	500	490
	kW	364	<b>364</b>	364	356	332	<b>332</b>	332	324	384	<b>384</b>	384	378	400	<b>400</b>	400	392
<b>LSA 47.3 M7</b>	kVA	500	<b>500</b>	500	490	465	<b>465</b>	465	449	550	<b>550</b>	550	519	570	<b>570</b>	570	539
	kW	400	<b>400</b>	400	392	372	<b>372</b>	372	359	440	<b>440</b>	440	415	456	<b>456</b>	456	431
<b>LSA 47.3 M8</b>	kVA	550	<b>550</b>	550	540	500	<b>500</b>	500	491	585	<b>585</b>	585	572	600	<b>600</b>	600	594
	kW	440	<b>440</b>	440	432	400	<b>400</b>	400	393	468	<b>468</b>	468	458	480	<b>480</b>	480	475
<b>LSA 47.3 L9</b>	kVA	600	<b>600</b>	600	500	545	<b>545</b>	545	455	635	<b>635</b>	635	530	660	<b>660</b>	660	550
	kW	480	<b>480</b>	480	400	436	<b>436</b>	436	364	508	<b>508</b>	508	424	528	<b>528</b>	528	440
<b>LSA 47.3 L10</b>	kVA	645	<b>660</b>	660	630	587	<b>600</b>	600	573	684	<b>730</b>	730	668	710	<b>745</b>	745	693
	kW	516	<b>528</b>	528	504	470	<b>480</b>	480	458	547	<b>584</b>	584	534	568	<b>596</b>	596	554

## Ratings 60 Hz - 1800 R.P.M.

kVA / kW - P.F. = 0.8																	
Duty / T° C		Continuous / 40 °C				Continuous / 40 °C				Stand-by / 40 °C				Stand-by / 27 °C			
Class / T° K		H / 125° K				F / 105° K				H / 150° K				H / 163° K			
Phase		3 ph.				3 ph.				3 ph.				3 ph.			
<b>Y</b>		380V	416V	440V	<b>480V</b>	380V	416V	440V	<b>480V</b>	380V	416V	440V	<b>480V</b>	380V	416V	440V	<b>480V</b>
<b>Δ</b>		220V	240V			220V	240V			220V	240V			220V	240V		
<b>YY</b>			208V	220V	<b>240V</b>		208V	220V	<b>240V</b>		208V	220V	<b>240V</b>		208V	220V	<b>240V</b>
<b>LSA 47.3 S4</b>	kVA	450	480	500	<b>512</b>	410	442	455	<b>465</b>	475	513	533	<b>550</b>	500	530	550	<b>581</b>
	kW	360	384	400	<b>410</b>	328	354	364	<b>372</b>	380	410	426	<b>440</b>	400	424	440	<b>465</b>
<b>LSA 47.3 S5</b>	kVA	475	510	531	<b>570</b>	441	473	493	<b>520</b>	505	543	566	<b>605</b>	527	562	585	<b>625</b>
	kW	380	408	425	<b>456</b>	353	378	394	<b>416</b>	404	434	453	<b>484</b>	422	450	468	<b>500</b>
<b>LSA 47.3 M7</b>	kVA	562	610	625	<b>625</b>	523	566	581	<b>590</b>	600	651	669	<b>680</b>	625	668	690	<b>700</b>
	kW	450	488	500	<b>500</b>	418	453	465	<b>472</b>	480	521	535	<b>544</b>	500	534	552	<b>560</b>
<b>LSA 47.3 M8</b>	kVA	562	610	630	<b>690</b>	523	566	587	<b>632</b>	600	651	672	<b>730</b>	625	671	705	<b>750</b>
	kW	450	488	504	<b>552</b>	418	453	470	<b>506</b>	480	521	538	<b>584</b>	500	537	564	<b>600</b>
<b>LSA 47.3 L9</b>	kVA	602	661	685	<b>750</b>	556	609	634	<b>685</b>	643	707	734	<b>795</b>	667	728	763	<b>825</b>
	kW	482	529	548	<b>600</b>	445	487	507	<b>548</b>	514	566	587	<b>636</b>	534	582	610	<b>660</b>
<b>LSA 47.3 L10</b>	kVA	650	715	755	<b>825</b>	590	650	685	<b>750</b>	690	760	800	<b>875</b>	720	785	830	<b>910</b>
	kW	520	572	604	<b>660</b>	472	520	548	<b>600</b>	552	608	640	<b>700</b>	576	628	664	<b>728</b>

Efficiencies 400V - 50 Hz (— P.F.: 0.8) (--- P.F.: 1)

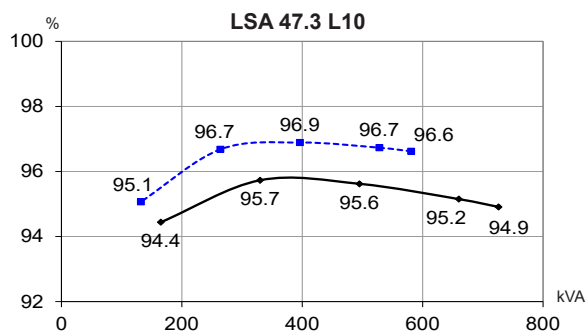
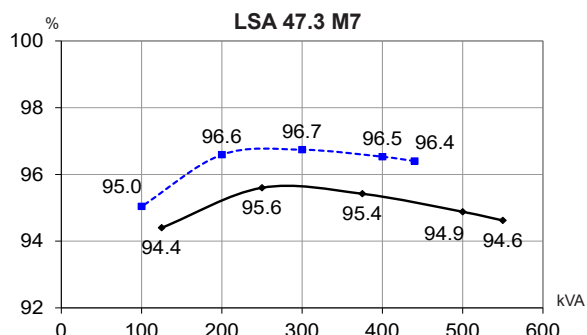
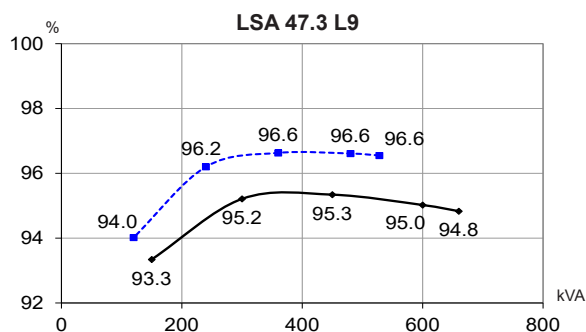
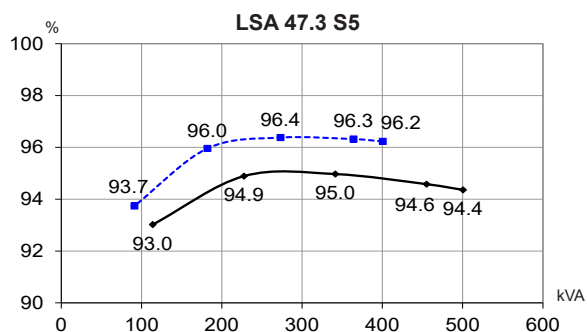
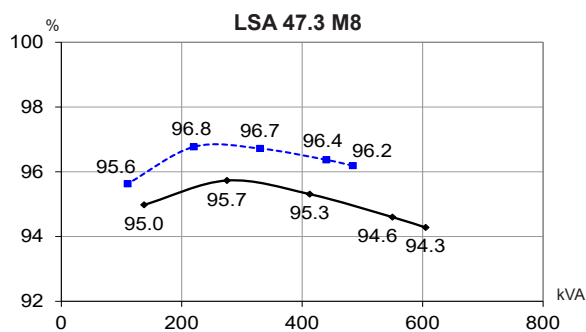
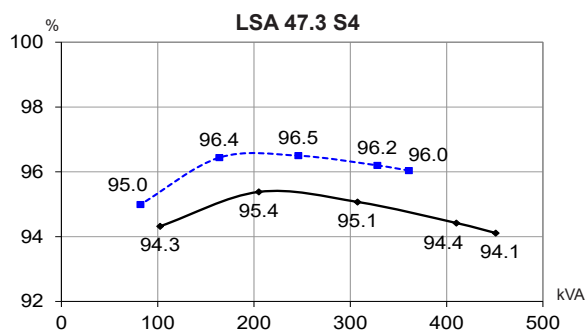

Reactances (%). Time constants (ms) - Class H / 400 V

	S4	S5	M7	M8	L9	L10
<b>Kcc</b> Short-circuit ratio	0.29	0.51	0.35	0.27	0.55	0.41
<b>Xd</b> Direct-axis synchronous reactance unsaturated	402	302	366	432	294	343
<b>Xq</b> Quadrature-axis synchronous reactance unsaturated	205	154	187	220	150	175
<b>T'do</b> No-load transient reactance constant	2068	2030	1968	1931	1881	1857
<b>X'd</b> Direct-axis transient reactance saturated	19.4	14.8	18.6	22.3	15.6	18.5
<b>T'd</b> Short-circuit transient time constant	100	100	100	100	100	100
<b>X''d</b> Direct-axis subtransient reactance saturated	11.2	8.5	10.7	12.8	9	10.6
<b>T''d</b> Subtransient time constant	10	10	10	10	10	10
<b>X''q</b> Quadrature-axis subtransient reactance saturated	12.6	10.1	13.6	17	12.5	15.2
<b>Xo</b> Zero sequence reactance	0.81	0.62	0.77	0.93	0.65	0.77
<b>X2</b> Negative sequence reactance saturated	11.93	9.34	12.17	14.96	10.78	12.92
<b>Ta</b> Armature time constant	15	15	15	15	15	15

Other class H / 400 V data

	S4	S5	M7	M8	L9	L10
<b>io (A)</b> No-load excitation current (SHUNT / AREP)	0.68	1.07	0.79	0.68	1.13	0.92
<b>ic (A)</b> On-load excitation current (SHUNT / AREP)	3.1	3.36	3.21	3.34	3.48	3.44
<b>uc (V)</b> On-load excitation voltage (SHUNT / AREP)	32.4	35	33.5	34.8	36.1	35.6
<b>ms</b> Response time ( $\Delta U = 20\%$ transient)	500	500	500	500	500	500
<b>kVA</b> Start ( $\Delta U = 20\%$ cont. or 30% trans.) SHUNT	1055	1178	1240	1237	1480	1615
<b>kVA</b> Start ( $\Delta U = 20\%$ cont. or 30% trans.) AREP	1269	1443	1490	1486	1805	1968
<b>%</b> Transient $\Delta U$ (on-load 4/4) SHUNT - P.F.: 0.8 <sub>LAG</sub>	12.8	10.3	15.5	14.3	15.7	12.1
<b>%</b> Transient $\Delta U$ (on-load 4/4) AREP - P.F.: 0.8 <sub>LAG</sub>	11	8.9	13.9	12.2	14.3	10.3
<b>W</b> No-load losses	4011	5871	4911	4544	7414	6486
<b>W</b> Heat dissipation	19374	20840	21557	25084	25152	26900

Transient voltage variation 400 V - 50 Hz

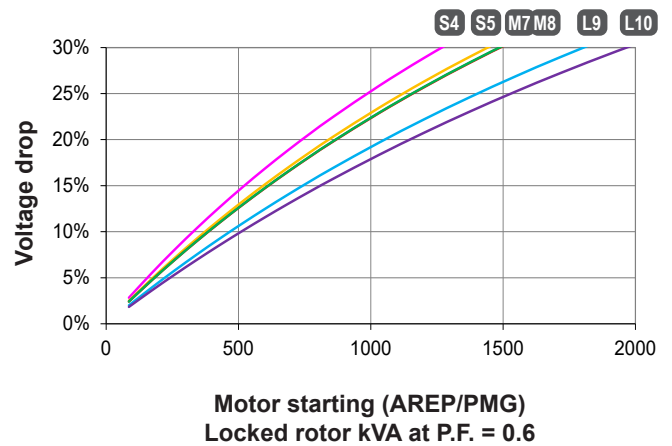
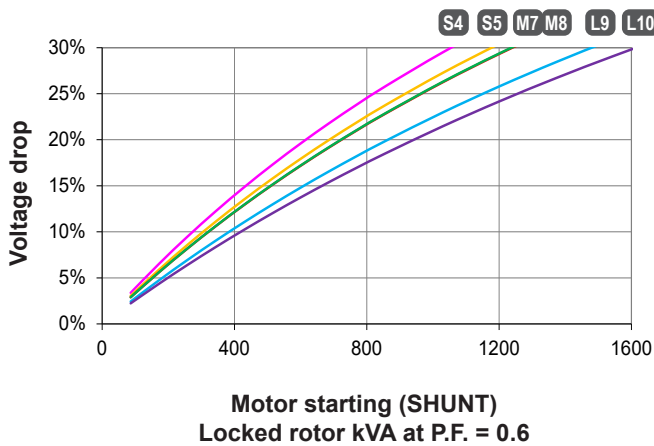
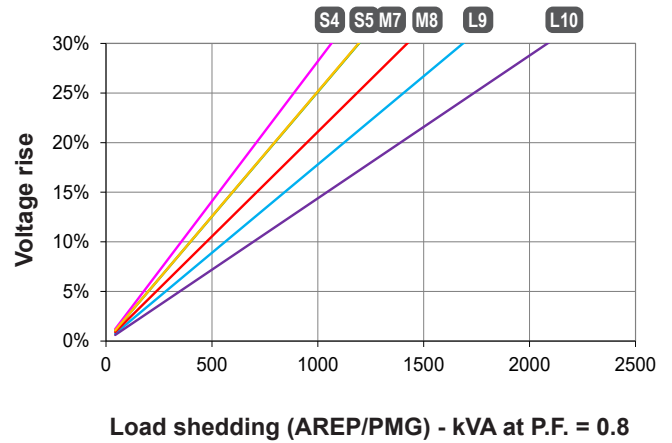
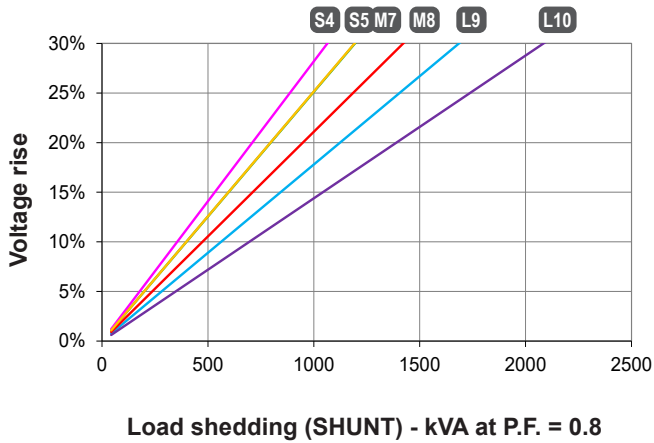
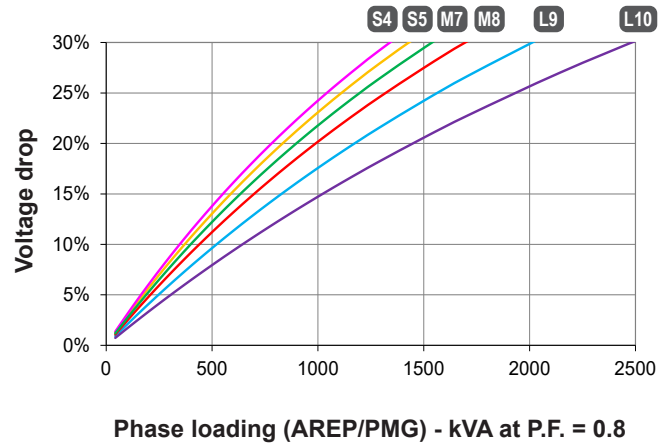
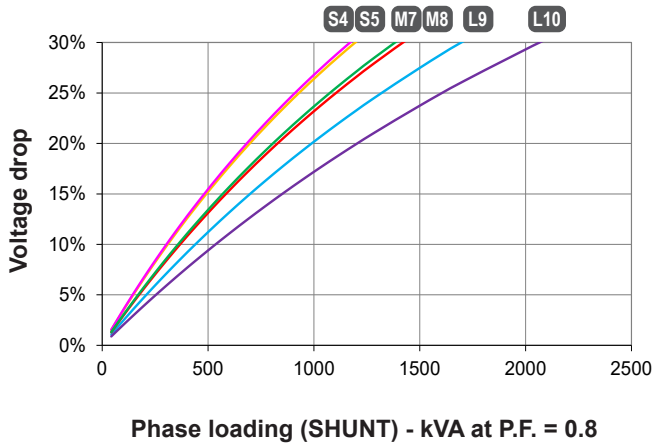

- 1) For a starting P.F. other than 0.6, the starting kVA must be multiplied by  $K = \text{Sine P.F.} / 0.6$
- 2) For voltages other than 400V (Y), 230V (Δ) at 50 Hz, then kVA must be multiplied by  $(400/U)^2$  or  $(230/U)^2$ .

Efficiencies 480 V - 60 Hz (— P.F.: 0.8) (--- P.F.: 1)

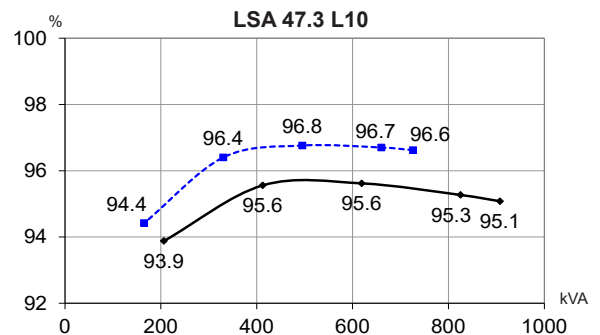
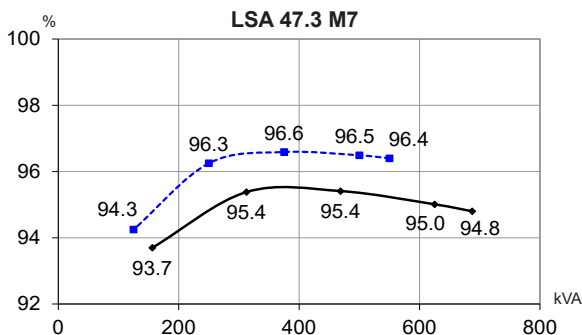
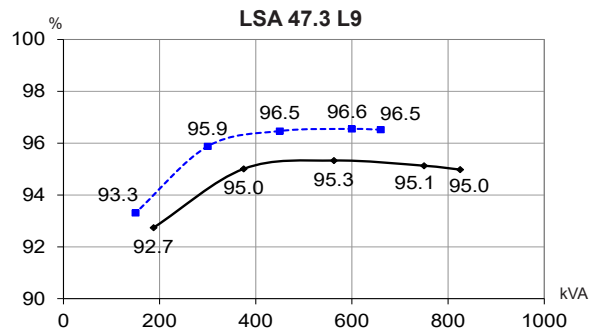
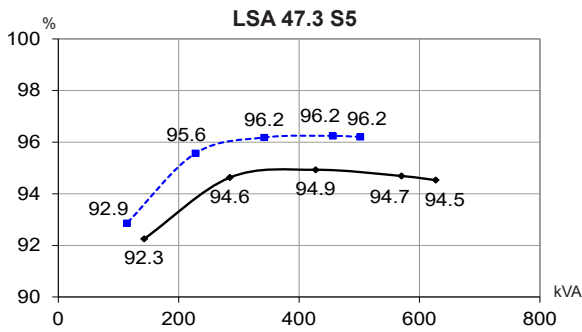
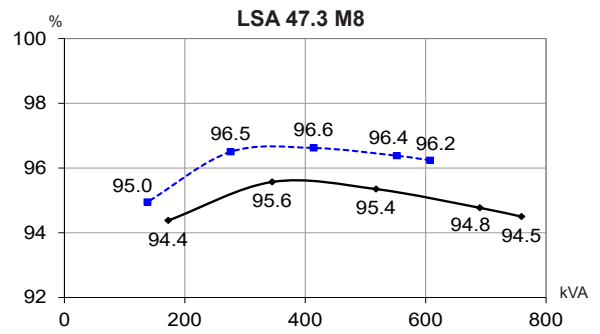
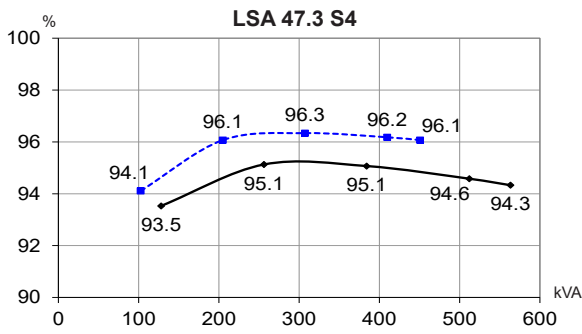

Reactances (%). Time constants (ms) - Class H / 480 V

	S4	S5	M7	M8	L9	L10
<b>Kcc</b> Short-circuit ratio	0.28	0.49	0.33	0.26	0.51	0.39
<b>Xd</b> Direct-axis synchronous reactance unsaturated	417	315	382	452	309	361
<b>Xq</b> Quadrature-axis synchronous reactance unsaturated	212	160	194	230	157	184
<b>T'do</b> No-load transient time constant	2068	2030	1968	1931	1881	1857
<b>X'd</b> Direct-axis transient reactance saturated	20.1	15.5	19.4	23.4	16.4	19.4
<b>T'd</b> Short-circuit transient time constant	100	100	100	100	100	100
<b>X''d</b> Direct-axis subtransient reactance saturated	11.5	8.9	11.1	13.4	9.4	11.1
<b>T''d</b> Subtransient time constant	10	10	10	10	10	10
<b>X''q</b> Quadrature-axis subtransient reactance saturated	13.1	10.5	14.2	17.8	13.2	15.9
<b>Xo</b> Zero sequence reactance	0.84	0.64	0.8	0.97	0.68	0.81
<b>X2</b> Negative sequence reactance saturated	12.35	9.75	12.68	15.64	11.33	13.58
<b>Ta</b> Armature time constant	15	15	15	15	15	15

Other class H / 480 V data

<b>io (A)</b> No-load excitation current (SHUNT / AREP)	0.68	1.07	0.79	0.68	1.11	0.91
<b>ic (A)</b> On-load excitation current (SHUNT / AREP)	3.17	3.42	3.28	3.43	3.51	3.49
<b>uc (V)</b> On-load excitation voltage (SHUNT / AREP)	33.2	35.8	34.3	35.8	36.6	36.3
<b>ms</b> Response time ( $\Delta U = 20\%$ transient)	500	500	500	500	500	500
<b>kVA</b> Start ( $\Delta U = 20\%$ cont. or 30% trans.) SHUNT	1268	1456	1495	1482	1849	2015
<b>kVA</b> Start ( $\Delta U = 20\%$ cont. or 30% trans.) AREP	1526	1791	1783	1780	2262	2460
<b>%</b> Transient $\Delta U$ (on-load 4/4) SHUNT - P.F.: 0.8 <sub>LAG</sub>	13.2	10.7	15.9	14.8	16.2	12.6
<b>%</b> Transient $\Delta U$ (on-load 4/4) AREP - P.F.: 0.8 <sub>LAG</sub>	11.3	9.2	14.2	12.7	14.7	10.7
<b>W</b> No-load losses	6196	8711	7429	6931	10718	9520
<b>W</b> Heat dissipation	23456	25534	26224	30403	30686	32721

Transient voltage variation 480 V - 60 Hz

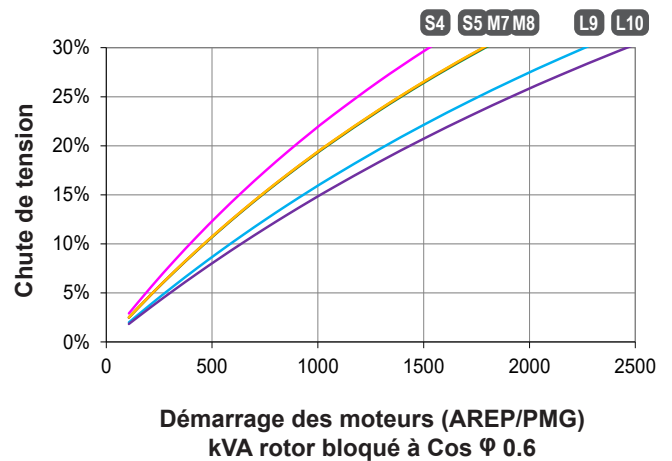
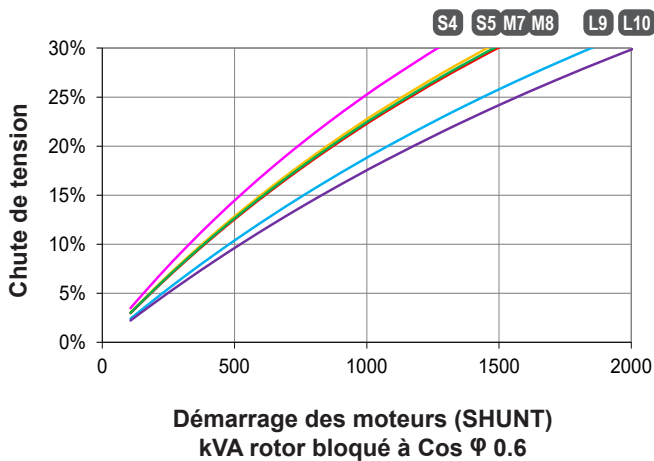
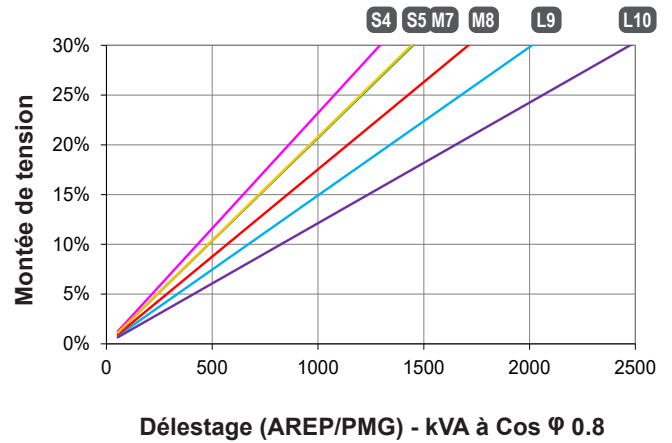
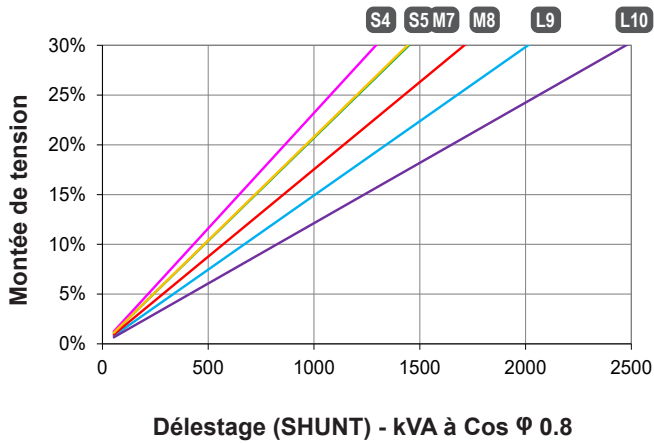
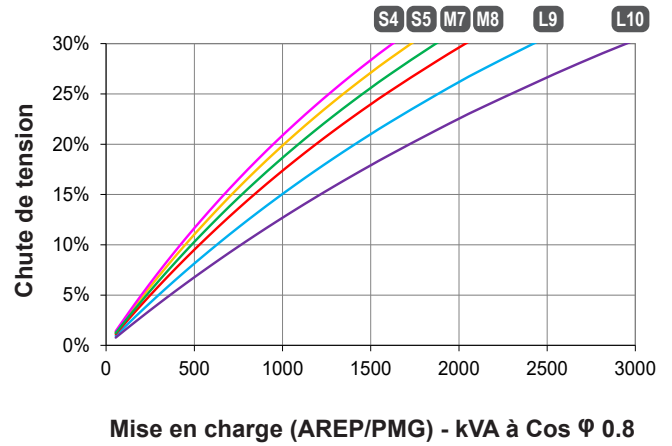
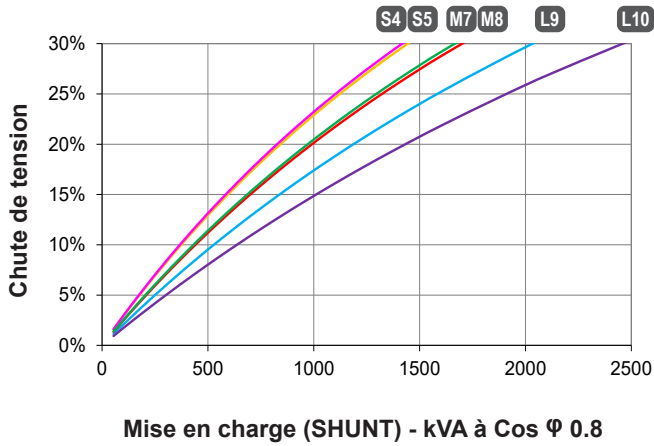

- 1) For a starting P.F. other than 0.6, the starting kVA must be multiplied by  $K = \text{Sine P.F.} / 0.6$
- 2) For voltages other than 480V (Y), 277V ( $\Delta$ ), 240V (YY) at 60 Hz, then kVA must be multiplied by  $(480/U)^2$  or  $(277/U)^2$  or  $(240/U)^2$ .

3-phase short-circuit curves at no load and rated speed (star connection Y)

LSA 47.3 S4

Symmetrical —  
Asymmetrical - - -

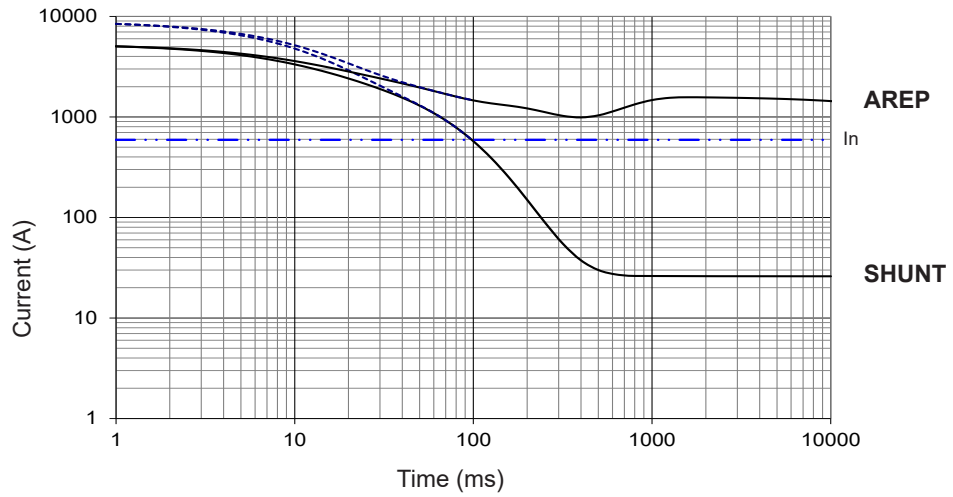

LSA 47.3 S5

Symmetrical —  
Asymmetrical - - -

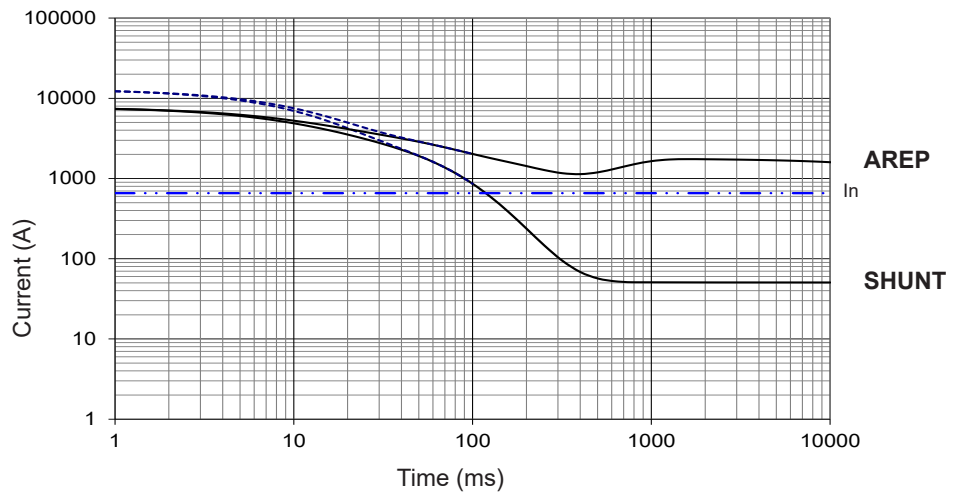

LSA 47.3 M7

Symmetrical —  
Asymmetrical - - -

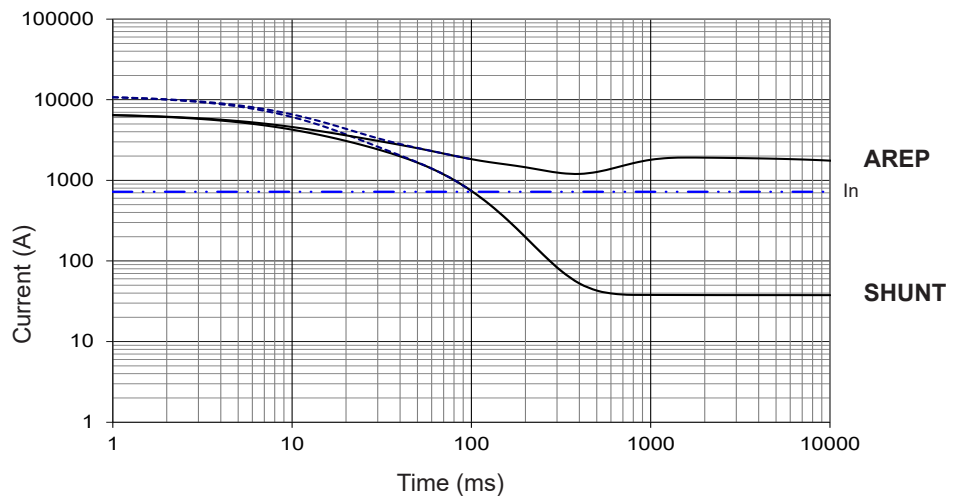

Influence due to connection

Curves shown are for star (Y) connection.

For other connections, use the following multiplication factors:

- Series delta : current value x 1.732 - Parallel star : current value x 2



3-phase short-circuit curves at no load and rated speed (star connection Y)

**LSA 47.3 M8**  
 Symmetrical —  
 Asymmetrical - - -

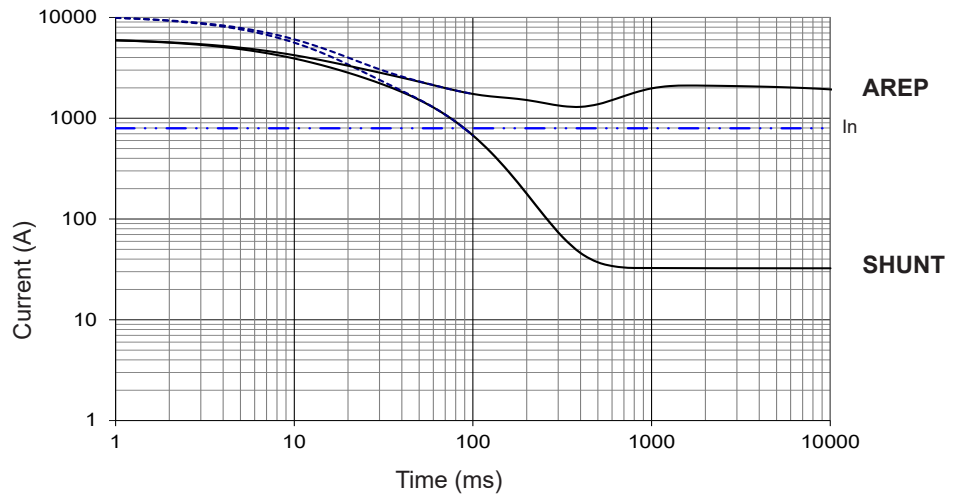

**LSA 47.3 L9**  
 Symmetrical —  
 Asymmetrical - - -

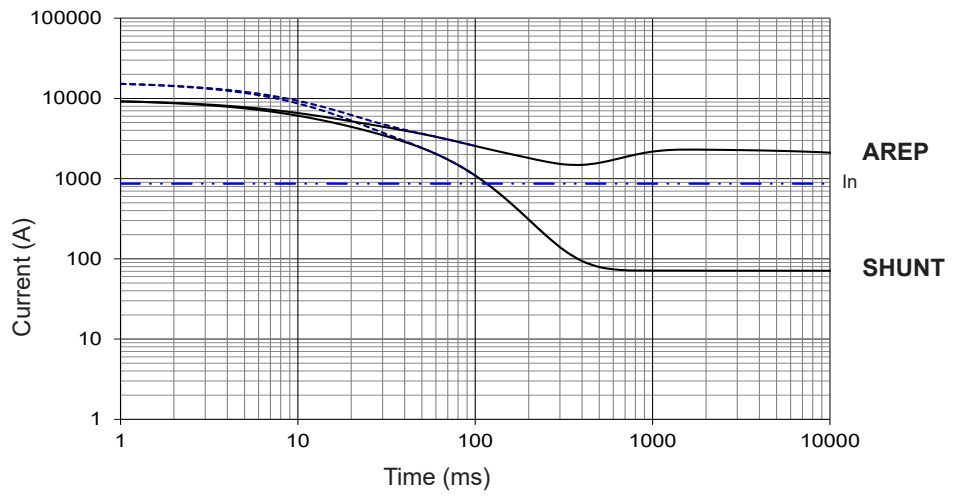

**LSA 47.3 L10**  
 Symmetrical —  
 Asymmetrical - - -

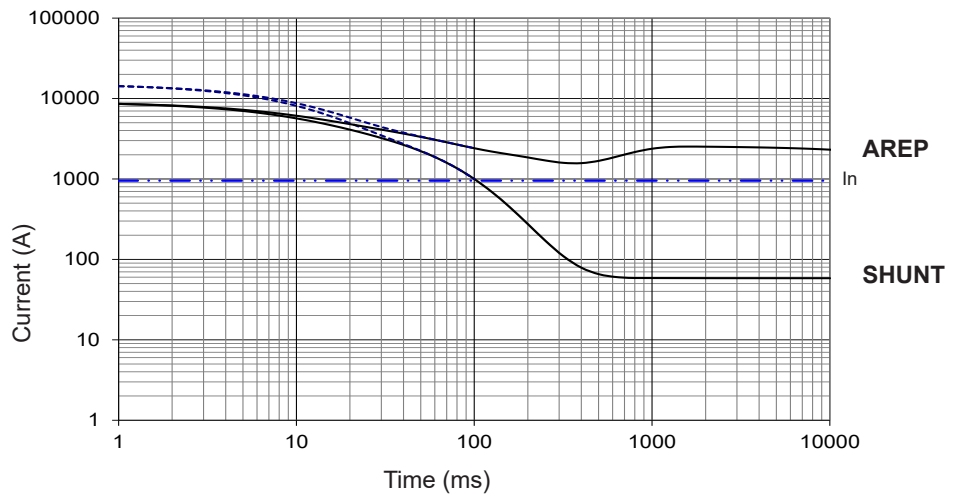

**Influence due to short-circuit**  
 Curves are based on a three-phase short-circuit.  
 For other types of short-circuit, use the following multiplication factors.

	3-phase	2-phase L/L	1-phase L/N
Instantaneous (max.)	1	0.87	1.3
Continuous	1	1.5	2.2
Maximum duration (AREP/PMG)	10 sec.	5 sec.	2 sec.



## Two-bearing dimensions

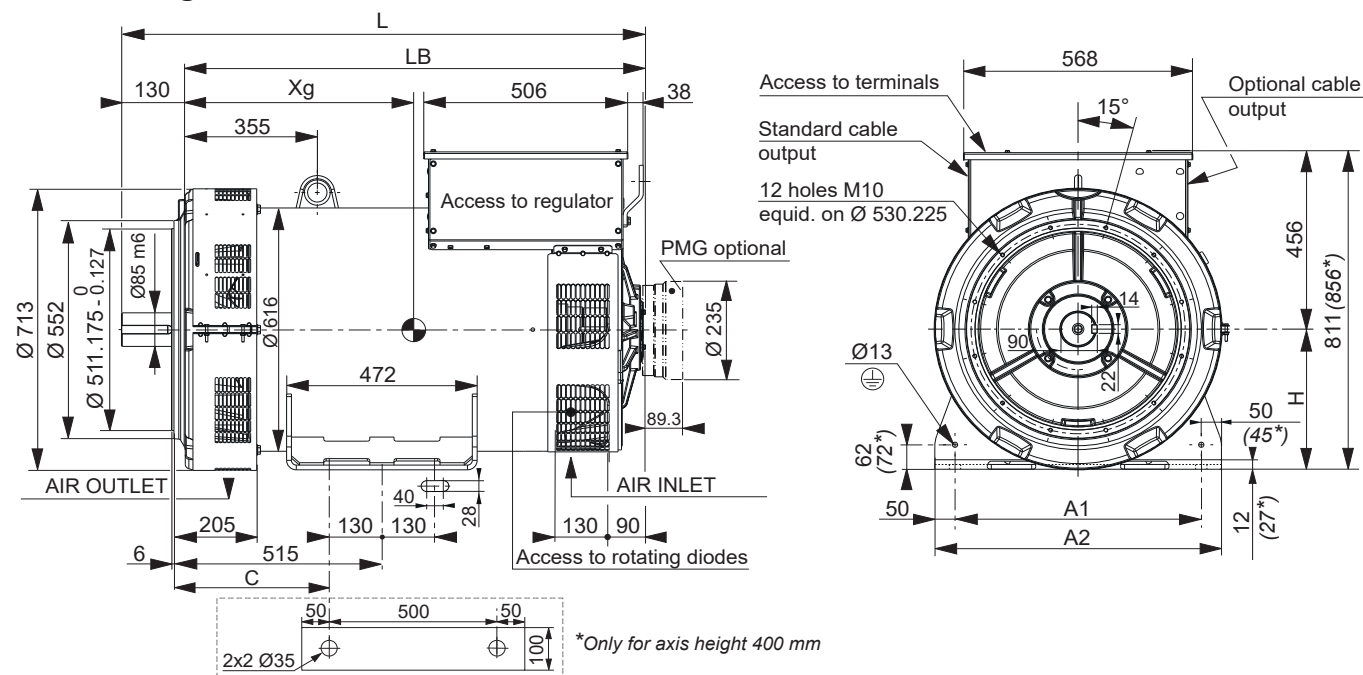

Dimensions (mm) and weight					Shaft height (mm)		
Type	L without PMG	LB	Xg	Weight (kg)	Standard		Option*
LSA 47.3 S4	1211	1081	473	1125	H	355 <sup>0</sup> <sub>2</sub>	400 <sup>0</sup> <sub>1</sub>
LSA 47.3 S5	1211	1081	479	1157	A1	610	686
LSA 47.3 M7	1311	1181	510	1245	A2	710	786
LSA 47.3 M8	1311	1181	519	1299	C	-	290
LSA 47.3 L9	1331	1201	537	1381	* Available only for L10		
LSA 47.3 L10	1331	1201	547	1429			

## Torsional analysis data

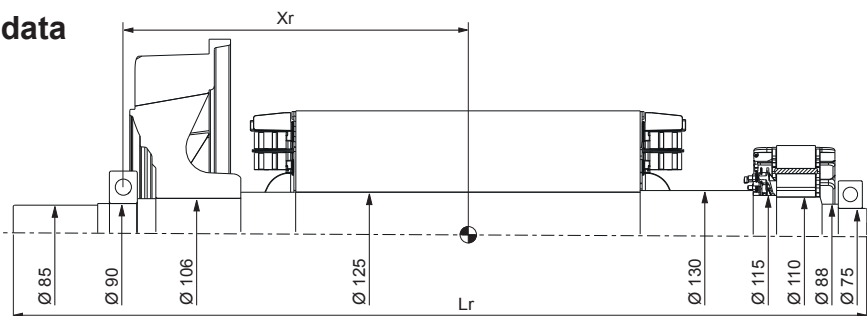

Centre of gravity: Xr (mm), Rotor length: Lr (mm), Weight: M (kg), Moment of inertia: J (kgm <sup>2</sup> ): (4J = MD <sup>2</sup> )				
Type	Xr	Lr	M	J
LSA 47.3 S4	430	1195	422	6.80
LSA 47.3 S5	437	1195	435	7.03
LSA 47.3 M7	466	1295	470	7.51
LSA 47.3 M8	477	1295	496	8
LSA 47.3 L9	497	1315	524	8.46
LSA 47.3 L10	508	1315	542	8.81

**NOTE :** Dimensions are for information only and may be subject to modifications. Contractual 2D drawings can be downloaded from the Leroy-Somer site, 3D drawing files are available upon request.  
The torsional analysis of the transmission is imperative. All values are available upon request.

**LEROY-SOMER**<sup>™</sup>

[www.leroy-somer.com/epg](http://www.leroy-somer.com/epg)

Connect with us at:



***Nidec***  
All for dreams

© 2022 Moteurs Leroy-Somer SAS. The information contained in this brochure is for guidance only and does not form part of any contract. The accuracy cannot be guaranteed as Moteurs Leroy-Somer SAS have an ongoing process of development and reserve the right to change the specification of their products without notice.

Moteurs Leroy-Somer SAS. Headquarters: Bd Marcellin Leroy, CS 10015, 16915 Angoulême Cedex 9, France. Share Capital: 38,679,664 €, RCS Angoulême 338 567 258.