

LSA 46.3

Low Voltage Alternator - 4 pole

230 to 365 kVA - 50 Hz / 288 to 456 kVA - 60 Hz
Electrical and mechanical data

LEROY-SOMER™

Nidec
All for dreams

The best of performance

Nidec Leroy-Somer LSA 46.3 alternator has been designed to offer you the best power generation performances. With its meticulous design and optimized architecture, the LSA 46.3 strikes the perfect balance between compactness, reliability, performance and longevity.

Whatever your application, the LSA 46.3 will meet your needs and will adapt to all situations.

Standards

Nidec Leroy-Somer LSA 46.3 alternator meets all key international standards and regulations, including IEC 60034, NEMA MG 1.32-33, ISO 8528-3, CSA C22.2 n°100-14 and UL 1446 (UL 1004 on request). Also compliant with IEC 61000-6-2, IEC 61000-6-3, IEC 61000-6-4, VDE 0875G, VDE 0875N and EN 55011, group 1 class A for European zone.

Nidec Leroy-Somer LSA 46.3 alternator can be integrated in EC marked generator set, and bears EC and CMIM markings. It is designed, manufactured and marketed in an ISO 9001 and ISO 14001 quality assurance environment.

Electrical characteristics and performances

- Class H insulation
- 2/3 pitch winding, standard 12-wire (6) reconnectable
- Voltage range:
 - 50 Hz: 220V - 240V and 380V - 415V (440V)
 - 60 Hz: 208V - 240V and 380V - 480V
- High efficiency and motor starting capacity
- Other voltages are possible with optional adapted windings:
 - 50 Hz: 440V (no. 7), 500V (no. 9), 550V (no. 22), 600V (no. 23), 690V (no. 10 or 52)
 - 60 Hz: 380V and 416V (no. 8), 600V (no. 9), 690V (no. 22)

Excitation and regulation system

Excitation system				Regulation options		
AVR	SHUNT	AREP (option)	PMG (option)	C.T. Current transformer for paralleling	Mains paralleling	Remote voltage potentiometer
R250	Standard					√
D350	Option	Standard	Standard	√*		√
D550	Option	Option	Option	√*	√	√

*: only with AREP or PMG

3-phase sensing is included as a standard with digital regulators.

Protection system and options

- The LSA 46.3 is IP 23
- Complete winding protection for clean environments with relative humidity ≤ 95 %, including indoor marine environments
- Options:
 - Filters on air inlet: derating 5%
 - Filters on air inlet and air outlet (IP 44): derating 10%
 - Reinforced winding protection for harsh environments and relative humidity greater than 95%
 - Space heater
 - Thermal protection for stator windings and shields

Mechanical construction

- Compact and rigid assembly to better withstand generator vibrations
- Steel frame
- Cast iron flanges and shields
- Two-bearing and single-bearing versions designed to be suitable for engines on the market
- Half-key balancing
- Greased for life bearings, regreasable bearings (optional)
- Direction of rotation: clockwise and anti-clockwise (without derating)

Terminal box design

- Easy access to the voltage regulator and to the connections
- Possible inclusion of accessories for paralleling, protection and measurement
- 9-way terminal block for voltage reconnection

LSA 46.3 - 230 to 365 kVA - 50 Hz / 288 to 456 kVA - 60 Hz

General characteristics

Insulation class	H	Excitation system	SHUNT	AREP / PMG
Winding pitch	2/3 (wind. 6)	AVR type	R250	D350
Number of wires	12	Voltage regulation (*)	± 0.5%	± 0.25%
Protection	IP 23	Short-circuit current	-	300% (3 IN) : 10s
Altitude	≤ 1000 m	Total Harmonic Distortion THD (**)	no load < 2.5% - on load < 2.5%	
Overspeed	2250 R.P.M.	Waveform: NEMA = TIF (**)	< 50	
Air flow	0.48 m³/s (50 Hz) / 0.58 m³/s (60 Hz)	Waveform: I.E.C. = THF (**)	< 2%	

(*) Steady state (**) Total harmonic distortion between phases, no-load or on-load (non-distorting)

Ratings 50 Hz - 1500 R.P.M.

kVA / kW - P.F. = 0.8																				
Duty/T°C	Continuous duty/40°C					Continuous duty/40°C					Stand-by/40°C			Stand-by/27°C						
Class/T°C	H/125°K					F/105°K					H/150°K			H/163°K						
Phase	3 ph.			1 ph.		3 ph.			1 ph.		3 ph.		1 ph.	3 ph.			1 ph.			
Y	380V	400V	415V	440V	ΔΔ	380V	400V	415V	440V	ΔΔ	380V	400V	415V	440V	ΔΔ	380V	400V	415V	440V	ΔΔ
Δ	220V	230V	240V		230V	220V	230V	240V		230V	220V	230V	240V		230V	220V	230V	240V		230V
YY		200V		220V			200V		220V			200V		220V			200V		220V	
LSA 46.3 S4 kVA	230	230	230	219	138	209	209	209	200	126	244	244	244	232	146	253	253	253	240	152
kW	184	184	184	175	110	167	167	167	160	101	195	195	195	186	117	202	202	202	192	122
LSA 46.3 S5 kVA	240	250	250	238	150	218	228	228	216	137	254	265	265	252	159	264	275	275	261	165
kW	192	200	200	190	120	174	182	182	173	110	204	212	212	202	127	211	220	220	209	132
LSA 46.3 M7 kVA	275	275	275	261	165	250	250	250	238	150	292	292	292	277	175	303	303	303	287	182
kW	220	220	220	209	132	200	200	200	190	120	234	234	234	222	140	242	242	242	230	146
LSA 46.3 M8 kVA	290	300	300	285	180	264	273	273	259	164	307	318	318	302	191	319	330	330	313	200
kW	232	240	240	228	144	211	218	218	207	131	246	254	254	242	153	255	264	264	250	160
LSA 46.3 L10 kVA	325	325	325	309	195	300	300	300	281	177	345	345	345	327	207	358	358	358	340	215
kW	260	260	260	247	156	240	240	240	225	142	276	276	276	262	166	286	286	286	272	172
LSA 46.3 L11 kVA	350	365	365	347	210	319	332	332	316	191	371	387	387	368	225	385	400	400	380	231
kW	280	292	292	277	168	255	266	266	253	153	297	310	310	294	180	308	320	320	304	185

Ratings 60 Hz - 1800 R.P.M.

kVA / kW - P.F. = 0.8																				
Duty/T°C	Continuous duty/40°C					Continuous duty/40°C					Stand-by/40°C			Stand-by/27°C						
Class/T°C	H/125°K					F/105°K					H/150°K			H/163°K						
Phase	3 ph.			1 ph.		3 ph.			1 ph.		3 ph.		1 ph.	3 ph.			1 ph.			
Y	380V	416V	440V	480V	ΔΔ	380V	416V	440V	480V	ΔΔ	380V	416V	440V	480V	ΔΔ	380V	416V	440V	480V	ΔΔ
Δ	220V	240V		240V		220V	240V		240V		220V	240V		240V		220V	240V		240V	
YY		208V	220V	240V			208V	220V	240V			208V	220V	240V			208V	220V	240V	
LSA 46.3 S4 kVA	226	250	262	288	152	206	227	238	262	138	240	264	278	305	161	250	274	288	316	167
kW	181	200	210	230	122	165	182	190	210	110	192	211	222	244	129	200	219	230	253	134
LSA 46.3 S5 kVA	245	265	280	313	165	223	241	255	284	150	260	281	297	331	175	270	292	308	344	182
kW	196	212	224	250	132	178	193	204	227	120	208	225	238	265	140	216	234	246	275	146
LSA 46.3 M7 kVA	275	300	315	344	182	250	273	287	313	165	292	318	334	364	192	303	330	347	378	200
kW	220	240	252	275	146	200	218	230	250	132	234	254	267	291	154	242	264	278	302	160
LSA 46.3 M8 kVA	290	315	340	375	200	264	287	309	337	180	307	334	360	395	210	319	347	375	412	218
kW	232	252	272	300	160	211	230	247	270	144	246	267	288	316	168	255	278	300	330	174
LSA 46.3 L10 kVA	315	345	365	406	215	287	314	332	370	195	334	366	387	431	227	347	380	402	447	236
kW	252	276	292	325	172	230	251	266	296	156	267	293	310	345	182	278	304	322	358	189
LSA 46.3 L11 kVA	360	393	419	456	231	328	358	381	415	210	382	417	444	483	250	396	432	461	502	254
kW	288	314	335	365	185	262	286	305	332	168	305	333	355	386	200	317	346	369	402	203

Efficiencies 400V - 50 Hz (— P.F.: 0.8) (--- P.F.: 1)

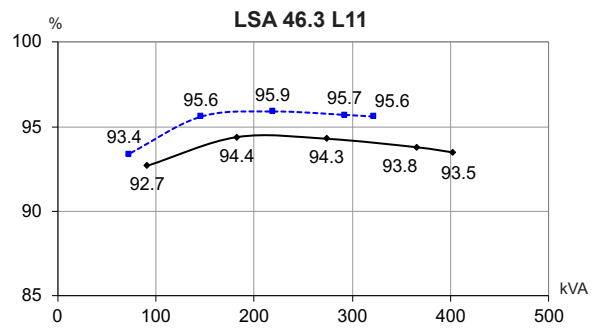
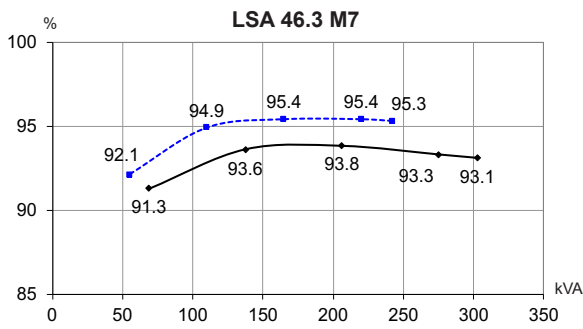
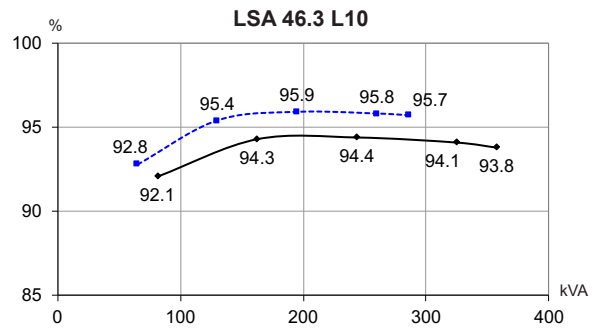
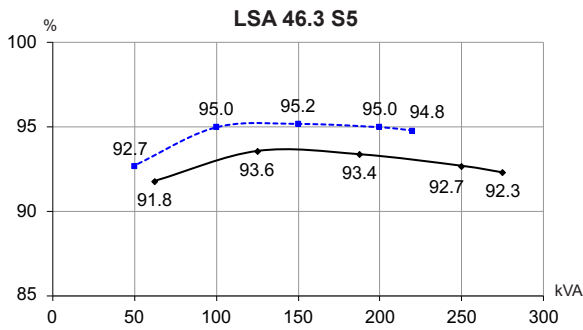
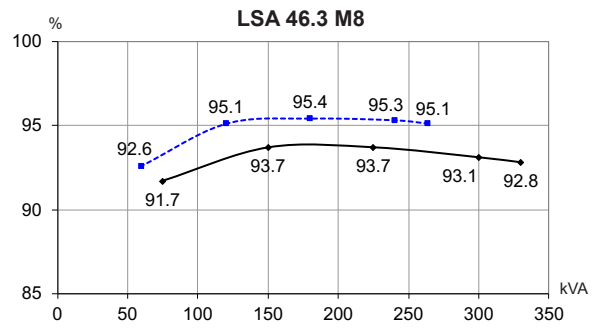
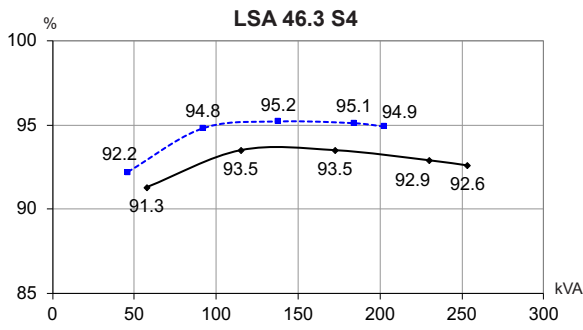

Reactances (%). Time constants (ms) - Class H / 400 V

	S4	S5	M7	M8	L10	L11
Kcc Short-circuit ratio	0.4	0.36	0.49	0.44	0.44	0.39
Xd Direct-axis synchronous reactance unsaturated	339	369	316	344	316	355
Xq Quadrature-axis synchronous reactance unsaturated	173	188	161	175	161	181
T'do No-load transient time constant	2452	2452	2543	2543	2686	2686
X'd Direct-axis transient reactance saturated	13.8	15	12.4	13.5	11.7	13.2
T'd Short-circuit transient time constant	100	100	100	100	100	100
X''d Direct-axis subtransient reactance saturated	11	12	9.9	10.8	9.4	10.5
T''d Subtransient time constant	10	10	10	10	10	10
X''q Quadrature-axis subtransient reactance saturated	14.6	15.9	13.1	14.3	12.6	14.1
Xo Zero sequence reactance	0.57	0.62	0.51	0.56	0.49	0.55
X2 Negative sequence reactance saturated	12.86	13.98	11.57	12.62	11.01	12.37
Ta Armature time constant	15	15	15	15	15	15

Other class H / 400 V data

io (A) No-load excitation current (SHUNT/AREP)	0.78	0.78	0.94	0.94	0.81	0.81
ic (A) On-load excitation current (SHUNT/AREP)	3.06	3.32	3.14	3.41	2.94	3.29
uc (V) On-load excitation voltage (SHUNT/AREP)	41.4	44.6	46.2	49.7	42.8	47.5
ms Response time ($\Delta U = 20\%$ transient)	500	500	500	500	500	500
kVA Start ($\Delta U = 20\%$ cont. or 30% trans.) SHUNT	554	557	667	664	791	790
kVA Start ($\Delta U = 20\%$ cont. or 30% trans.) AREP	639	640	736	738	876	880
% Transient ΔU (on-load 4/4) SHUNT - P.F.: 0.8 _{LAG}	13.2	14	13.6	14.4	13.6	14.7
% Transient ΔU (on-load 4/4) AREP - P.F.: 0.8 _{LAG}	12.4	13.1	12.7	13.5	12.6	13.7
W No-load losses	3660	3660	4449	4449	4775	4775
W Heat dissipation	13869	15662	15583	17615	16271	19169

Transient voltage variation 400V - 50 Hz

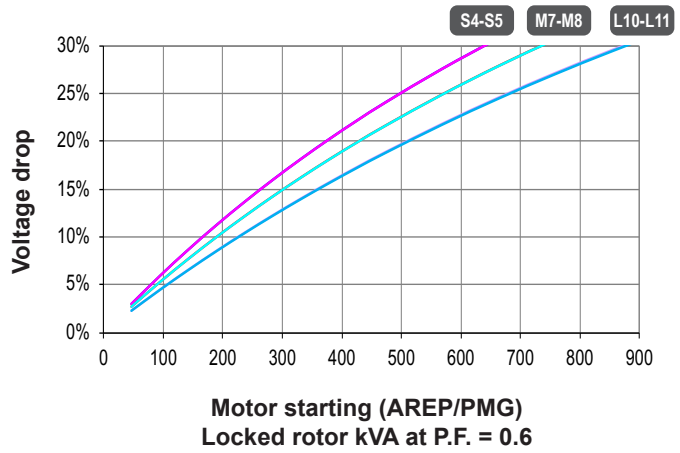
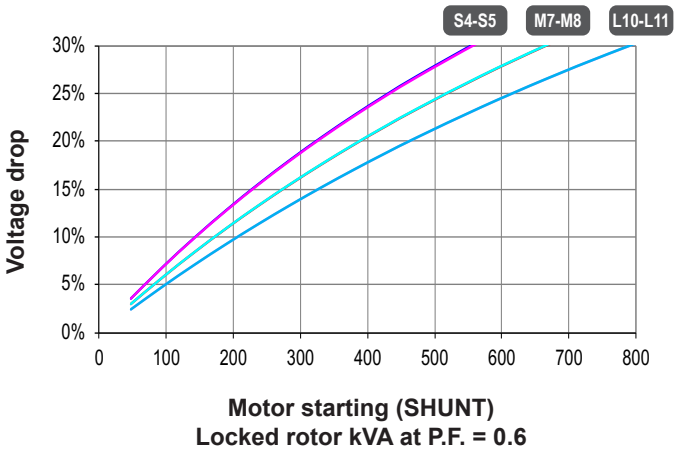
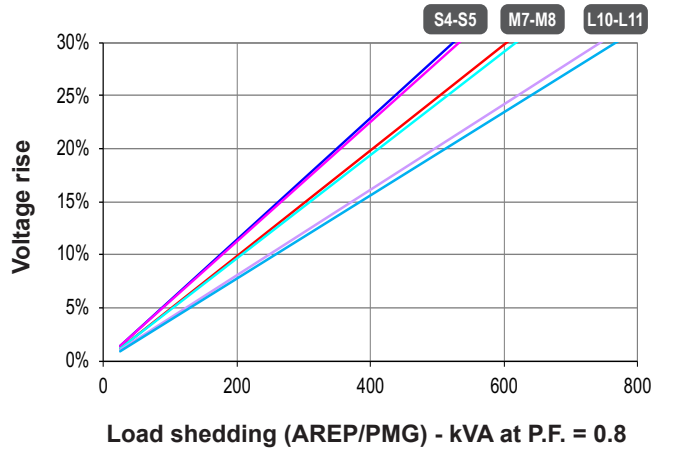
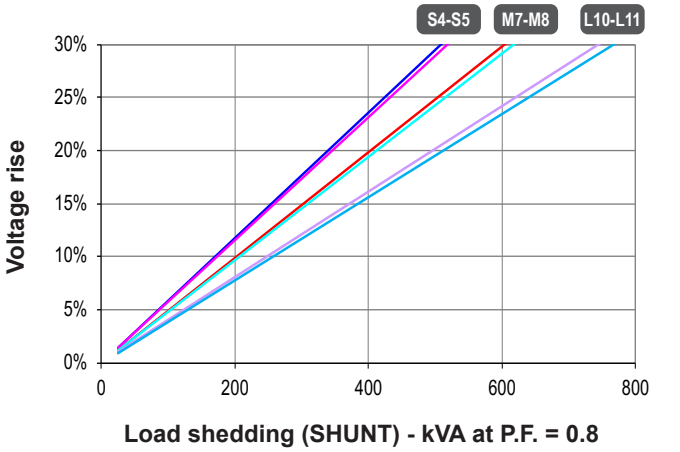
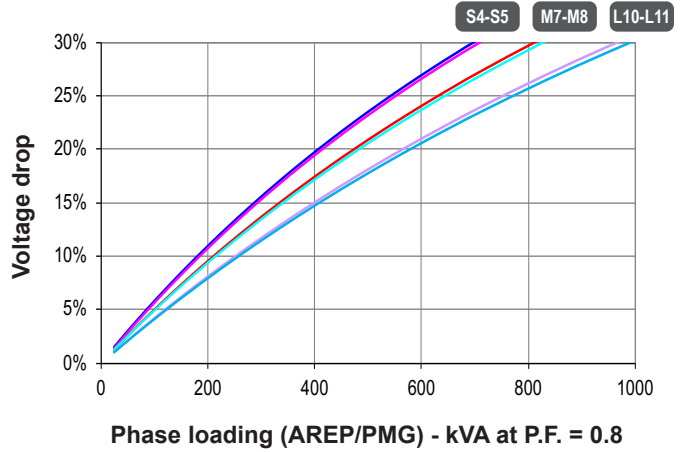
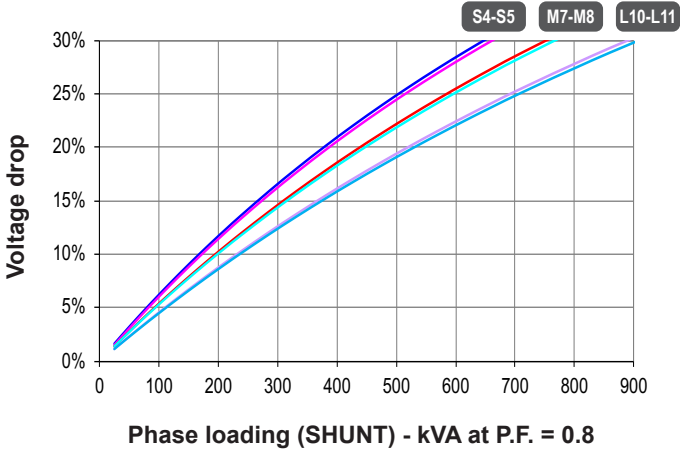

- 1) For a starting P.F. other than 0.6, the starting kVA must be multiplied by $K = \text{Sine P.F.} / 0.6$
- 2) For voltages other than 400V (Y), 230V (Δ) at 50 Hz, then kVA must be multiplied by $(400/U)^2$ or $(230/U)^2$.

Efficiencies 480V - 60 Hz (— P.F.: 0.8) (--- P.F.: 1)

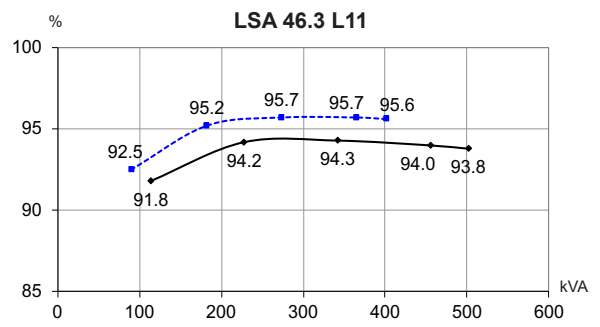
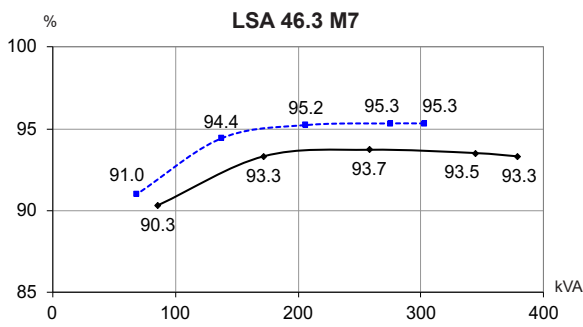
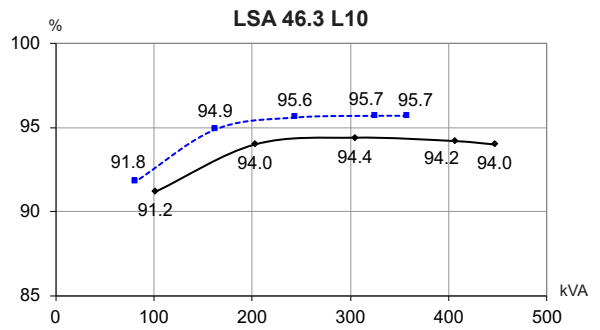
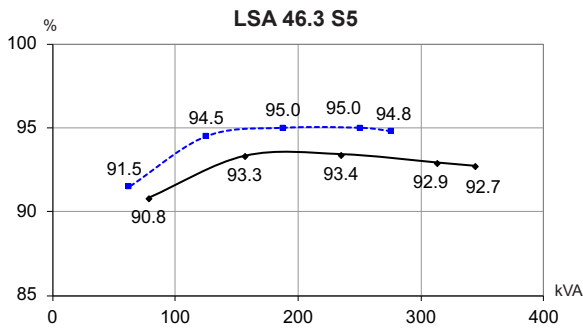
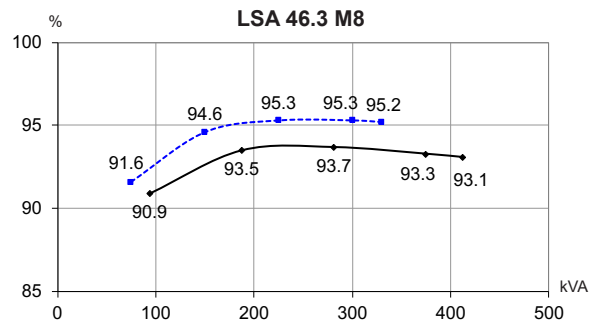
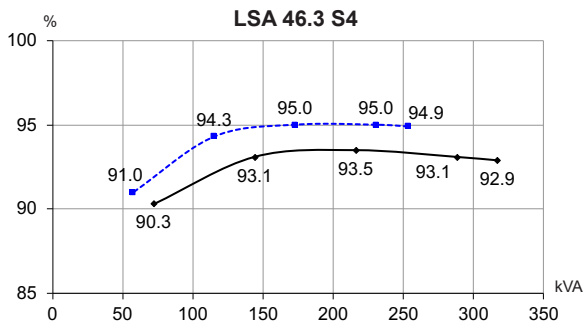

Reactances (%). Time constants (ms) - Class H / 480 V

	S4	S5	M7	M8	L10	L11
Kcc Short-circuit ratio	0.38	0.35	0.47	0.43	0.42	0.37
Xd Direct-axis synchronous reactance unsaturated	354	385	329	359	329	370
Xq Quadrature-axis synchronous reactance unsaturated	180	196	168	183	168	188
T'do No-load transient time constant	2452	2452	2543	2543	2686	2686
X'd Direct-axis transient reactance saturated	14.4	15.7	12.9	14.1	12.2	13.7
T'd Short-circuit transient time constant	100	100	100	100	100	100
X''d Direct-axis subtransient reactance saturated	11.5	12.5	10.3	11.2	9.8	11
T''d Subtransient time constant	10	10	10	10	10	10
X''q Quadrature-axis subtransient reactance saturated	15.2	16.6	13.7	14.9	13.1	14.1
Xo Zero sequence reactance	0.6	0.65	0.53	0.58	0.51	0.57
X2 Negative sequence reactance saturated	13.42	14.58	12.06	13.14	11.46	12.87
Ta Armature time constant	15	15	15	15	15	15

Other class H / 480 V data

io (A) No-load excitation current (SHUNT/AREP)	0.78	0.78	0.94	0.94	0.81	0.81
ic (A) On-load excitation current (SHUNT/AREP)	3.05	3.3	3.13	3.38	2.92	3.26
uc (V) On-load excitation voltage (SHUNT/AREP)	41.7	44.9	46.5	50	43.1	47.7
ms Response time ($\Delta U = 20\%$ transient)	500	500	500	500	500	500
kVA Start ($\Delta U = 20\%$ cont. or 30% trans.) SHUNT	699	695	799	800	947	945
kVA Start ($\Delta U = 20\%$ cont. or 30% trans.) AREP	765	766	887	883	1055	1053
% Transient ΔU (on-load 4/4) SHUNT - P.F.: 0.8 _{LAG}	13.6	14.4	14	14.9	13.9	15.1
% Transient ΔU (on-load 4/4) AREP - P.F.: 0.8 _{LAG}	12.8	13.5	13.1	13.8	13	14
W No-load losses	5549	5549	6617	6617	7115	7115
W Heat dissipation	16897	18905	18951	21212	19891	23158

Transient voltage variation 480V - 60 Hz

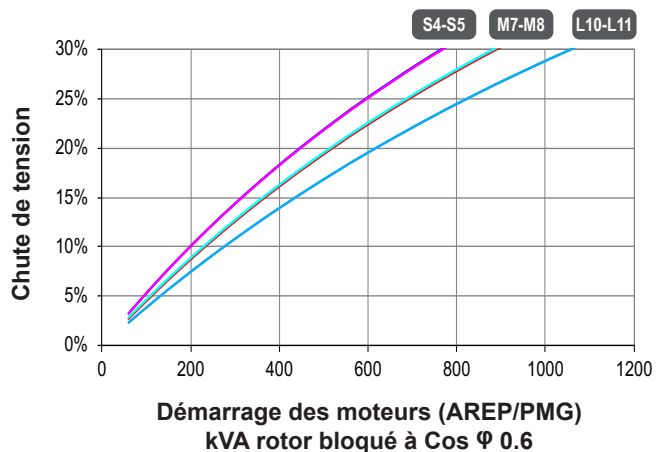
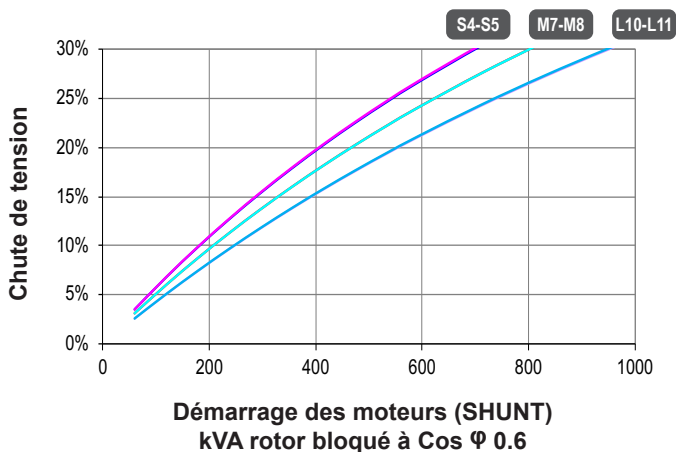
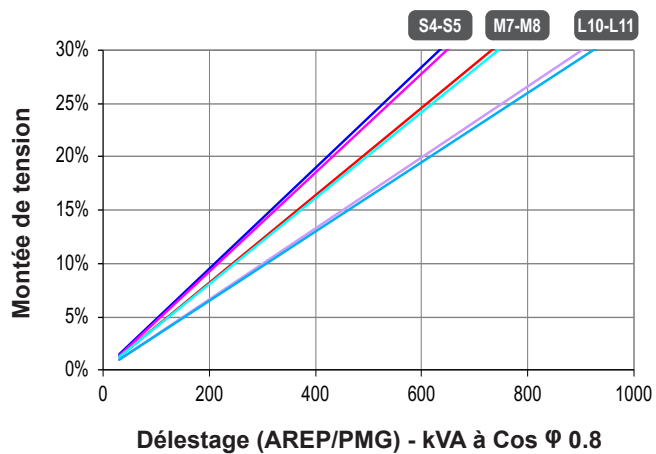
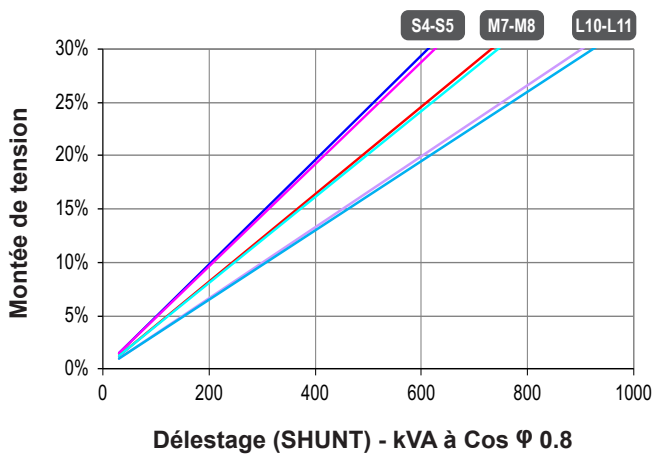
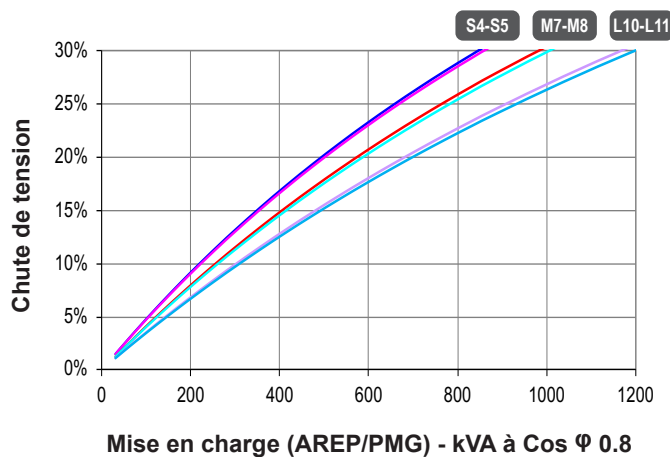
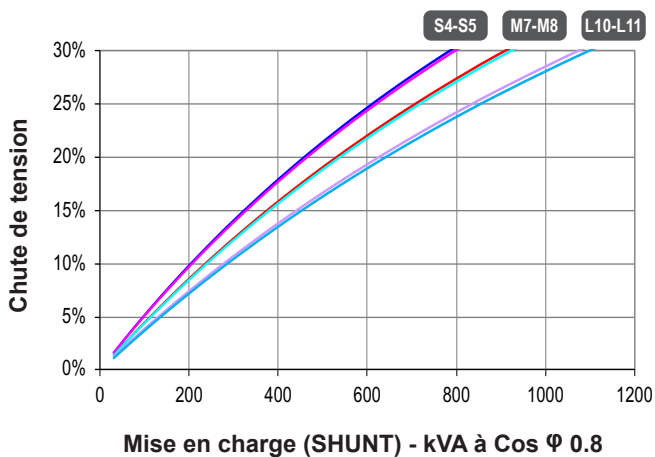

- 1) For a starting P.F. other than 0.6, the starting kVA must be multiplied by $K = \text{Sine P.F.} / 0.6$
- 2) For voltages other than 480V (Y), 277V (Δ), 240V (YY) at 60 Hz, then kVA must be multiplied by $(480/U)^2$ or $(277/U)^2$ or $(240/U)^2$.

3-phase short-circuit curves at no load and rated speed (star connection Y)

LSA 46.3 S4

Symmetrical —
Asymmetrical - - -

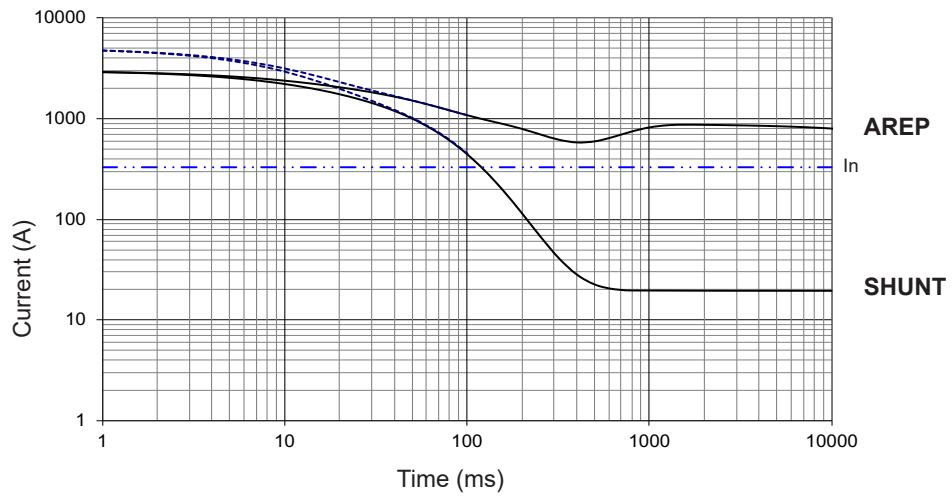

LSA 46.3 S5

Symmetrical —
Asymmetrical - - -

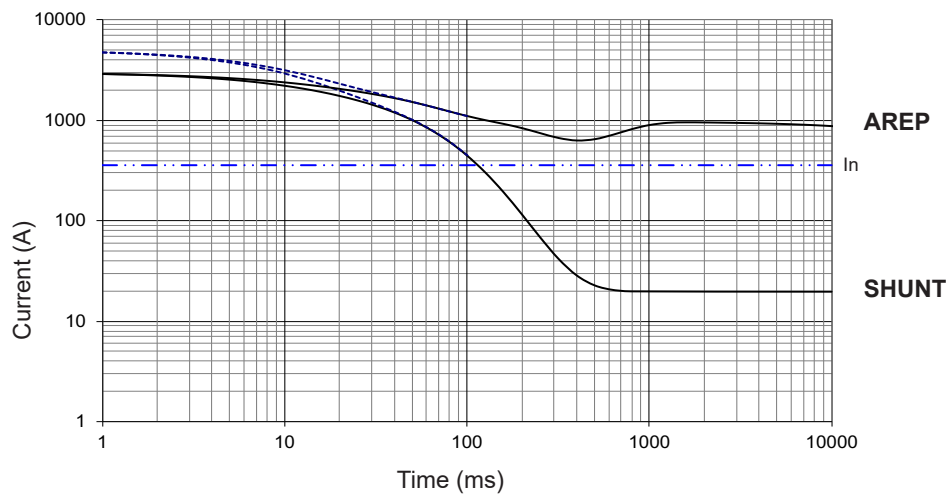

LSA 46.3 M7

Symmetrical —
Asymmetrical - - -

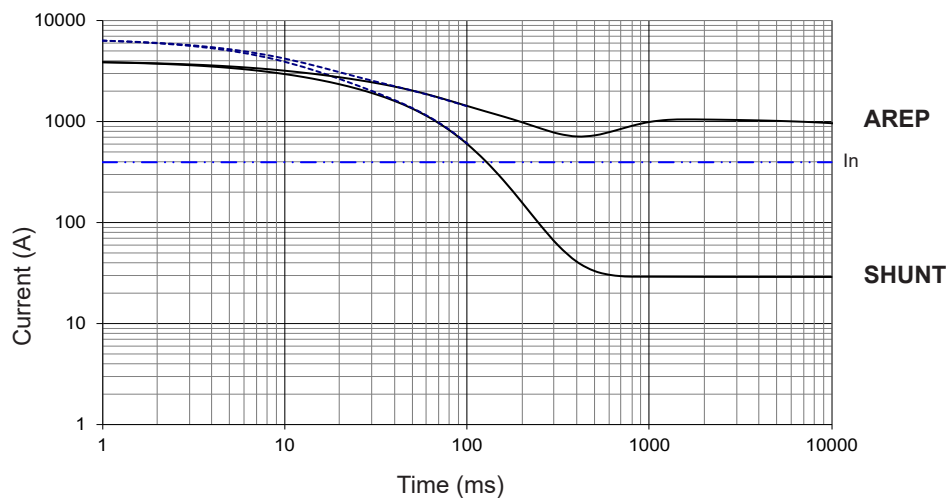

Influence due to connection

Curves shown are for star (Y) connection.

For other connections, use the following multiplication factors:

- Series delta : current value x 1.732 - Parallel star : current value x 2

3-phase short-circuit curves at no load and rated speed (star connection Y)

LSA 46.3 M8

Symmetrical —
Asymmetrical - - -

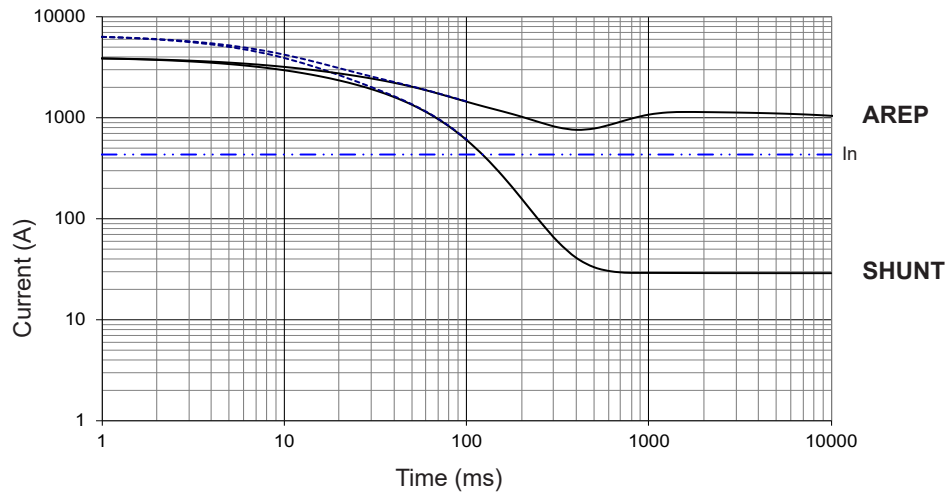

LSA 46.3 L10

Symmetrical —
Asymmetrical - - -

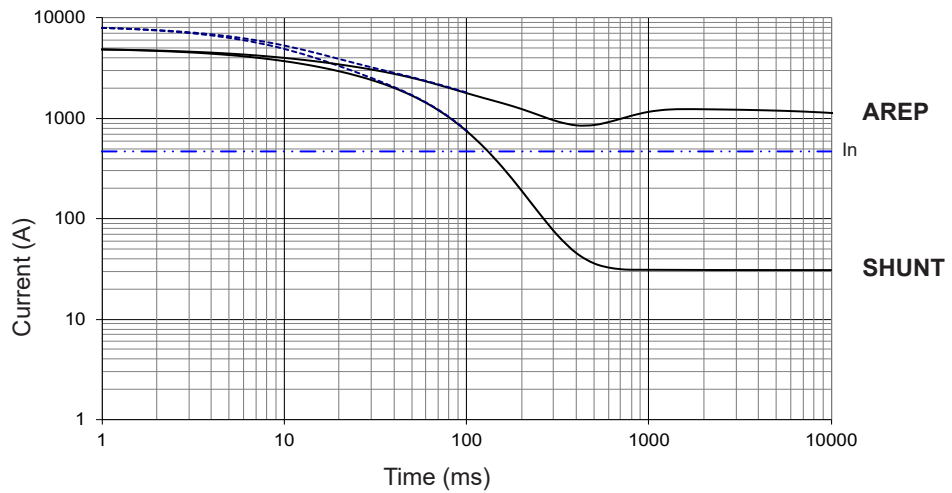

LSA 46.3 L11

Symmetrical —
Asymmetrical - - -

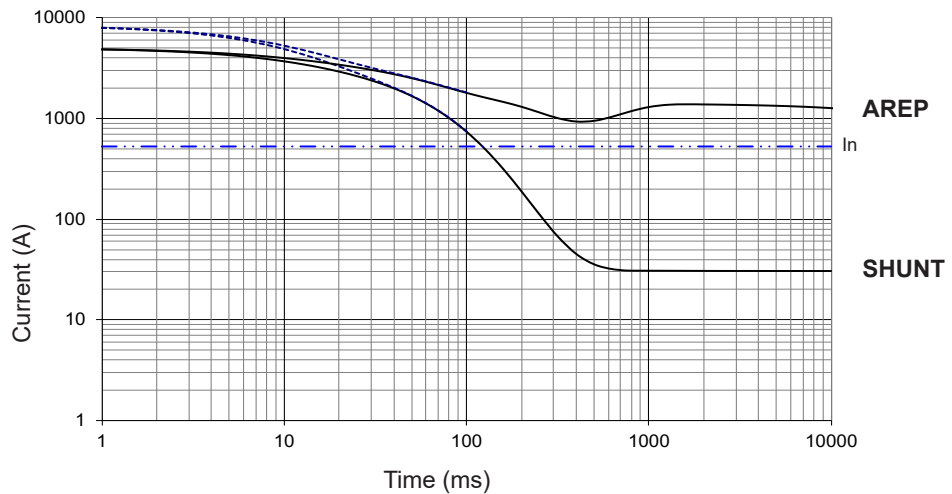

Influence due to short-circuit

Curves are based on a three-phase short-circuit.

For other types of short-circuit, use the following multiplication factors.

	3-phase	2-phase L/L	1-phase L/N
Instantaneous (max.)	1	0.87	1.3
Continuous	1	1.5	2.2
Maximum duration (AREP/PMG)	10 sec.	5 sec.	2 sec.

Single-bearing dimensions

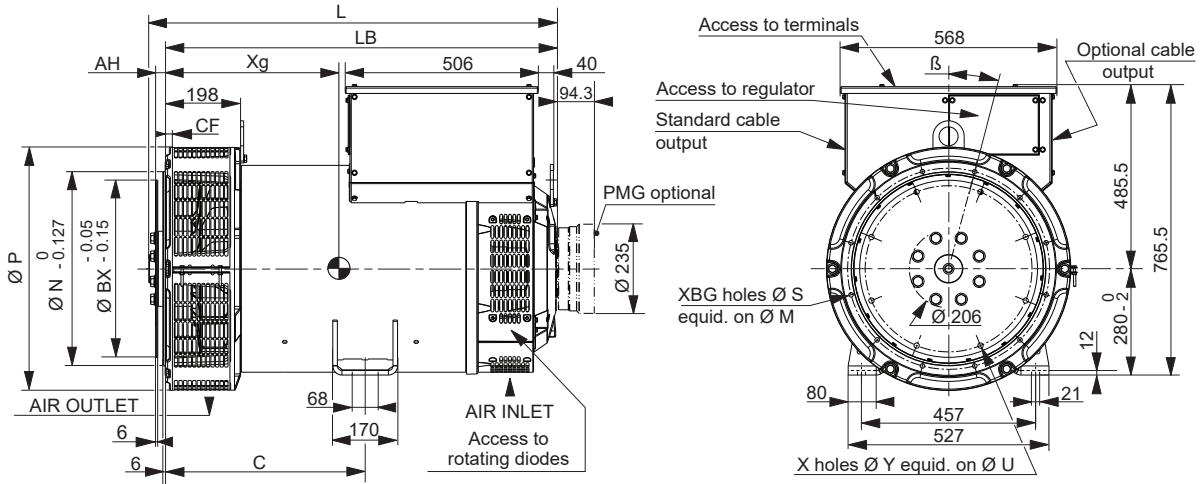

Dimensions (mm) and weight						Coupling			
Type	L without PMG maxi*	LB	Xg	C	Weight (kg)	Flex plate	11 ½	14	18
LSA 46.3 S4	944	892	423	429	674	Flange S.A.E 3	X		
LSA 46.3 S5	944	892	423	429	682	Flange S.A.E 2	X		
LSA 46.3 M7	989	937	445	429	754	Flange S.A.E 1	X	X	
LSA 46.3 M8	989	937	445	429	754	Flange S.A.E ½		X	
LSA 46.3 L10**	1084	1032	493	525	888	Flange S.A.E 0		X	X
LSA 46.3 L11**	1084	1032	493	525	888			X	X

* L maxi = LB + AH maxi + 12.4 (only for SAE 11 ½) ** Shaft height = 355 mm optional

Flange (mm)								Flex plate (mm)					
S.A.E.	P	N	M	XBG	S	β°	CF	S.A.E.	BX	U	X	Y	AH
3	600*/641	409.575	428.625	12	11	15°	10	11 ½	352.42	333.38	8	11	39.6
2	600*/641	447.675	466.725	12	11	15°	10	14	466.72	438.15	8	14	25.4
1	600*/641	511.175	530.225	12	12	15°	10	18*	571.5	542.92	6	17	15.7
½	713	584.2	619.125	12	14	15°	6						
0	713	647.7	679.45	16	14	11° 15'	19						

* Specific dimension LSA 46.3 S4

Torsional analysis data

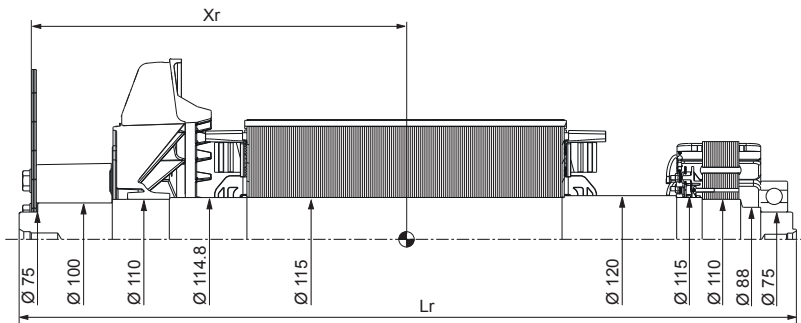

Centre of gravity: Xr (mm), Rotor length: Lr (mm), Weight: M (kg), Moment of inertia: J (kgm²): (4J = MD²)									
Flex plate	S.A.E. 11 ½				S.A.E. 14				
	Type	Xr	Lr	M	J	Xr	Lr	M	J
LSA 46.3 S4		431	928	277	2.93	416	928	277	3.09
LSA 46.3 S5		431	928	277	2.93	416	928	277	3.09
LSA 46.3 M7		459	973	307	3.23	444	973	307	3.39
LSA 46.3 M8		459	973	307	3.32	444	973	307	3.39
LSA 46.3 L10		507	1068	362	3.96	493	1068	362	4.12
LSA 46.3 L11		507	1068	362	3.96	493	1068	362	4.12

NOTE : Dimensions are for information only and may be subject to modifications. Contractual 2D drawings can be downloaded from the Leroy-Somer site, 3D drawing files are available upon request. The torsional analysis of the transmission is imperative. All values are available upon request.

Two-bearing dimensions

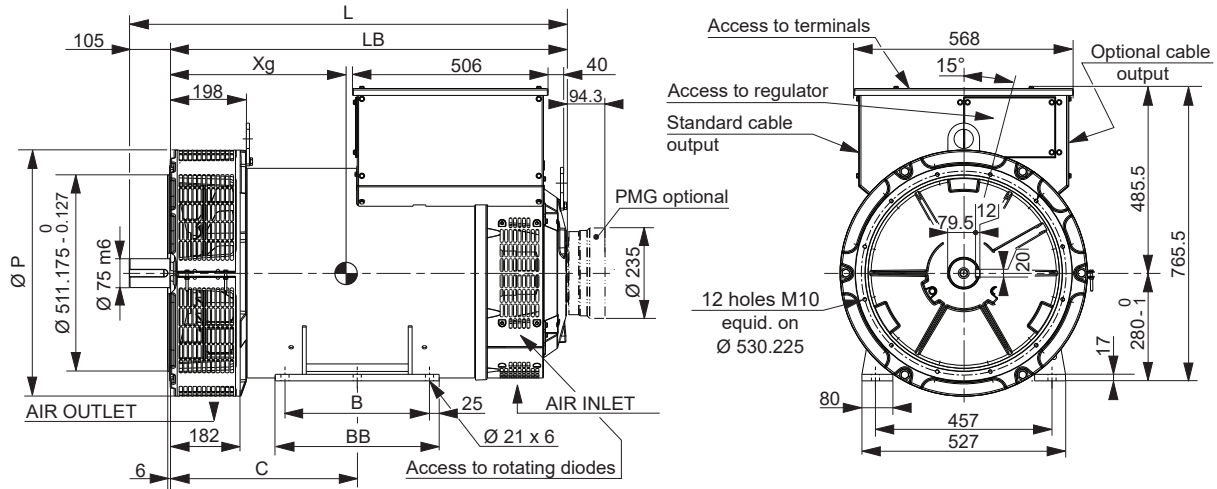

Dimensions (mm) and weight								
Type	L without PMG	LB	C	BB	B	P	Xg	Weight (kg)
LSA 46.3 S4	997	892	389	368	318	600	427	674
LSA 46.3 S5	997	892	389	368	318	640	427	682
LSA 46.3 M7	1042	937	389	368	318	640	449	754
LSA 46.3 M8	1042	937	389	368	318	640	449	754
LSA 46.3 L10	1137	1032	485	424	374	640	496	888
LSA 46.3 L11	1137	1032	485	424	374	640	496	888

Torsional analysis data

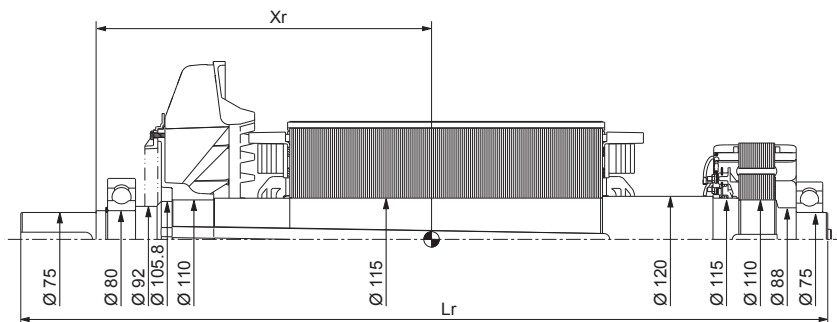

Centre of gravity: Xr (mm), Rotor length: Lr (mm), Weight: M (kg), Moment of inertia: J (kgm ²): (4J = MD ²)				
Type	Xr	Lr	M	J
LSA 46.3 S4	430	990	250	2.76
LSA 46.3 S5	430	990	250	2.76
LSA 46.3 M7	456	1035	280	3.09
LSA 46.3 M8	456	1035	280	3.09
LSA 46.3 L10	503	1130	336	3.79
LSA 46.3 L11	503	1130	336	3.79

NOTE : Dimensions are for information only and may be subject to modifications. Contractual 2D drawings can be downloaded from the Leroy-Somer site, 3D drawing files are available upon request.
The torsional analysis of the transmission is imperative. All values are available upon request.

LEROY-SOMER[™]

www.leroy-somer.com/epg

Connect with us at:



Nidec
All for dreams

© 2022 Moteurs Leroy-Somer SAS. The information contained in this brochure is for guidance only and does not form part of any contract. The accuracy cannot be guaranteed as Moteurs Leroy-Somer SAS have an ongoing process of development and reserve the right to change the specification of their products without notice.

Moteurs Leroy-Somer SAS. Headquarters: Bd Marcellin Leroy, CS 10015, 16915 Angoulême Cedex 9, France. Share Capital: 38,679,664 €, RCS Angoulême 338 567 258.